

SPACEWALKER

1/3 Scale



Craftman's Kit

SIGRC61



BUILDING AND FLYING INSTRUCTIONS

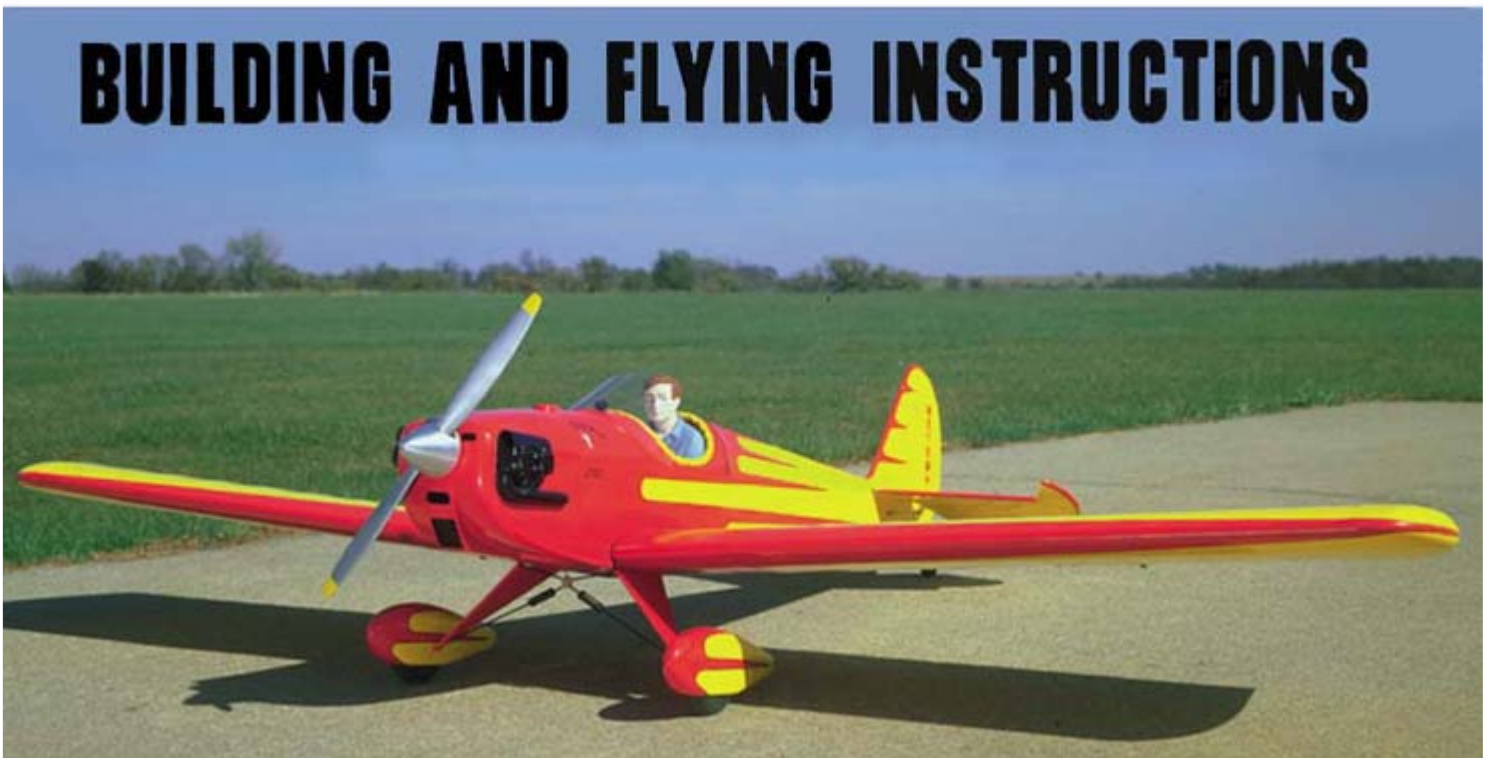

Sig Mfg. Co., Inc....401-7 South Front Street...Montezuma, Iowa 50171

The Spacewalker Story

In the small town of Henderson, North Carolina, lives a man who has been quietly designing and selling his homebuilt designs for several years now. His J-3 Kitten won Best New Design at the 1983 Sun-'N-Fun EAA Fly-In. He won a Grand Champion Prize at Oshkosh in 1984 with his J-4 Sportster, and in 1985 at Oshkosh, his J-6 Karatoo won the Outstanding New Design award. This prolific designer then decided to build himself a personal fun plane and in 1986 it flew for the first time. That airplane was named the Spacewalker and the designer of all of these prize-winners was Jesse Anglin.

The general layout of the spacewalker (low-wing, open-cockpit taildragger) was inspired by a ride that Jessie had in a PT-19 years ago. Power is provided by a 65 h.p. Continental with it's cylinders hanging in the breeze like a cub. Even though it was meant to be a personal airplane, public reaction has convinced him to market the plans and sell component parts through his company, Country Air, Inc.

The classic lines of the Spacewalker remind most aviation enthusiasts of Pete Bower's Fly Baby or the Ryan trainers. One writer even thought at first glance it was a Les Long creation of the Great Depression era. This is exactly the kind of feeling that Jesse wanted to evoke with this design. With ultra-efficient, gas-sipping, cross-country machines dominating the homebuilt industry today, it is strangely refreshing to see a brand new airplane designed solely for the pure pleasure of flight.

The Spacewalker fuselage is a welded steel tubing structure with wood formers and stringers in the turtledeck to give it some shape. The wing is fully cantilevered with a massive center section main spar and box spars in the outer wing panels. Drag loads are handled by diagonal compression trusses between the spars. The wing ribs are routed out of 1/4" plywood and the wingtips are molded fiberglass. The tail surfaces are simple welded steel tubing. Jesse sells plans for the Spacewalker as well as many component parts, including the completely welded fuselage frame.

When Maxey Hester (then Vice-President, Sig Mfg. Co.) saw a picture of the Spacewalker in the EAA magazine (Sport Aviation), he decided that a model of this airplane would be the perfect showplane for his new four-cylinder O.S. Pegasus engine. In December '86, he and Hazel Sig visited with Jesse Anglin and returned to Montezuma with a full set of plans for the full-scale Spacewalker and announced that they were going to build one! After waiting many months to receive all of the component parts from Jesse, work on the full-scale bird commenced here at the Sig factory. With much help from Dorothy and Burnis Fields of Interlachen, Florida, Maxey had his airplane finished and ready to fly in twelve weeks! It was the first Spacewalker, other than Jesse's, to be finished and flown.

Jesse Anglin has made many changes to his Spacewalker since it first flew. Originally, only the rear set of tail brace wires were installed and the exhaust pipes on the engine flared outward at the ends. Jesse said that the open pipes gave the airplane a distinctive sound, but it was just too loud to live with. The pipes were later routed into the cowl where they met at a centre muffler. Two more pipes route the exhaust straight down out of the bottom of the cowling. Jesse also added another set of tail brace wires to the front of the stabilizer at about the same time the changes were made to the exhaust system. Several months later he changed the shape of the windshield to improve the looks and wind protection. Also the engine originally had no cylinder cooling shrouds, but after a long cross-country trip in hot weather, he decided that they were needed. His latest change was to clip the outer wing panels two rib bays on each side.



On the other hand, Maxey had not made any visible changes to his airplane - he was happy with it just the way it was. More Spacewalkers were then being constructed all around the country. Most of these would probably have some minor differences in appearance because most homebuilder's love to modify designs to suit their taste. Maxey stuck very closely to the plans, so his airplane was almost identical to Jesse's except for the color of the paint!

About The Sig Model

The Sig 1/3 scale Spacewalker was designed with an eye towards scale construction techniques. The plywood ribs with lightening holes, the box spar with laminated spruce caps, the detachable wing panels, and the open fuselage framework are all copied from the full-scale bird. Most of the models built from this kit will end up weighing about 20 pounds, giving a wing loading of 25.6 oz./sq.ft.

We are all very excited about the flight performance of the model. We've never seen an airplane with that long of a wing and that much dihedral do rolls so axially. And according to Jesse Anglin, the full-scale Sapcewalker has the same trait. Loops, snaps, spins, and inverted flight are all so easy to do. With 1800 sq.in. of wing area, landings are slow and stable. As for its scale accuracy, it was designed using the full-scale drawings. This is one airplane that will definately put a smile on the faces of scale and sport pilots alike!

Scale Data Sources

Builders that plan to enter their Spacewalkers in competition will need to collect some scale data on the particular aircraft they have chosen to model. The following list of sources should prove helpful.

- **SIG MFG. CO.**-Color photo packs of both Jesse's (black and red) and Maxey's (red and yellow) airplanes.

- **KITPLANES, September 1988** -This issue features a beautiful color cover shot of Hazel and Maxey in their Spacewalker flying over the Iowa landscape. The accompanying article on pages 26-31 is the definitive piece of literature on the two aircraft to date. Full color photos include flight shots, ground shots (with models), and one of Hazel's instrument panel. Article by LeRoy Cook.



- **KITPLANES, August 1988** -A color photo on page 11 features Maxey's Spacewalker at Sun-'N-Fun '88 when his N number was still on the side of the fuselage. Jesse's and Hazel's airplanes are in the background, each with a model displayed.
- **SCALE R/C MODELER, August 1988** -On page 52 is a color photo similar to the previous month's cover shot. Although smaller, this photo shows more detail. A Sig model is in the foreground.
- **SCALE R/C MODELER, July 1988** -Cover photo. Although this color cover shot isn't particularly useful for documentation, it is a nice close-up photo of Hazel sitting in her Spacewalker at the 1988 Atlanta IMS Show.
- **SPORT AVIATION, October 1986** -On page 21 is a good color flight shot of the Spacewalker with Jesse at the controls. This is the photo that originally attracted Maxey to the design and led to his first trip to Jesse's hanger a few weeks later.
- **LIGHT PLANE WORLD, October 1986** -Complete article and photo study. Photos show the airplane with the original windshield and exhaust system.
- **HOMEBUILT AIRCRAFT, March 1987** -Complete article and photo study, including precover construction photos. The original windshield and exhaust system are shown.
- **SPORT AVIATION, July 1987** -On page 40 is a striking color photo taken at Sun-'N-Fun '87 of Jesse's airplane with our first prototype model next to it. The article is entitled "Dynamic Modeling," but there's no mention of the Spacewalker.
- **PRIVATE PILOT, June 1987** -On page 69, is another small photo of Jesse's bird and the scale model at Sun-'N-Fun. Interestingly, the caption reads "Skywalker," a common mistake when talking about this airplane.
- **KITPLANES, July 1987** -The Spacewalker is featured on the cover of this issue. It is a flight shot with Jesse at the controls wearing his "color coordinated" helmet. The helmet is a feature you may want to add to your scale pilot. Shows the original windshield, new exhaust system, and no cylinder shrouds. Inside is another color shot and a short article.
- **SPORT PILOT, July 1987** -There's an inset photo on the cover with Jesse flying over a beach. The article features a two page color photo of N107JA in flight and many black and white photos, including one of the instrument panel. Again, this has the old windshield, new exhaust, and no cylinder shrouds. The article is very good and includes a pilot report.

COMPLETE KIT PARTS LIST

Die-Cut Balsa

1	1/8"x3"x20-1/2" Sheet No.1 FS-1, FS-2, Apron pieces			
---	---	--	--	--

Silkscreened Balsa

2	1/4"x3"x14" Sheet No.2 WS-1, WS-2, WS-3	1	3/8"x4"x27" Sheet No.3 Stab, Elevator, Rudder Parts		
---	---	---	---	--	--

Sheet Balsa

2	3/32"x1"x36" Bottom Wing Sheeting, Center Sheeting	4	3/32"x1-1/2"x30" Center Section T.E., & Aileron Well Sheeting	4	3/32"x1-1/2"x36" Outer Panel T.E. Sheeting	2	3/32"x2"x36" Aileron Top, Center Section, & Servo Bay Sheeting
4	3/32"x3"x30" Center Section Sheeting	4	3/32"x3"x36" Wing Panel E. Sheeting	3	1/8"x4"x21" Front Deck Sheeting	2	3/16"x1-1/2"x30" Aileron Leading Edge
1	3/16"x4"x12" Landing Gear Fill-In	2	1/4"x3"x12" Main Frame Fill-In	2	3/8"x4"x4-1/2" Fuselage Bottom		

Block Balsa

2	1/2"x3-1/4"x2" L.G. Support Block	2	5/8"x3-1/4"x1" L.G. Support Block		
---	-----------------------------------	---	-----------------------------------	--	--

Stick Balsa							
18	3/32"x1/4"x36" Capstrips	2	3/32"x3/4"x30" Bottom Aileron Sheeting	1	1/8"x1/8"x24" Top Main Spar Spacers	8	1/8"x1/4"x36" Aileron Spars, Fill-Strips, Fabric Attach Strips
7	1/8"x3/8"x36" Top Stringers, Cable Exit Guides, Fill-Strips	3	1/8"x3/4"x36" Leading Edges	2	3/16"x1/4"x18" Fill-Strips	3	3/16"x3/8"x36" Tail Surface Diagonal Ribs
18	1/4"x1/4"x36" Forward Spars, Main Frames, Cross-Braces, Stringers	6	1/4"x1/2"x36" Rear Spars	3	1/4"x7/8"x36" Leading Edge Caps	3	3/8"x3/8"x36" Tail Surface Ribs
5	3/8"x3/4"x36" Tail Surface Frames	1	3/8" Triangle x2-1/2" Fin L.E. Brace	1	3/4" Triangle x36" PW Brace, Hold-down Block Brace, L.G. Block Brace	1	1" Triangle x8" Firewall Brace
1	1/2"x 1-1/2"x8" Special Shaped T.E. Fill-In Block						
Hardwood							
1	3/8"x1"x1-1/2" BASSWOOD Control Horn Mount	2	1/2"x19/32"x4" BASSWOOD Rear L.G. Blocks, Grooved	2	1/2"x1"x4" BASSWOOD Front L.G. Blocks, Grooved	2	3/4"x3/4"x3" BASSWOOD Wing Mounting Blocks
2	3/16" dia.x2-1/2" BIRCH DOWELS Pushrod Ends	2	5/16" dia.x1-1/2" BIRCH DOWELS Wing Hold-Down Dowels				
Spruce							
5	1/8"x3/8"x36" Stringers, Stab and Fin Brace	4	1/8"x3/4"x6" Main Spar Laminate	4	1/8"x3/4"x17-7/8" Main Spar Laminate	4	1/8"x3/4"x30-1/8" Main Spar Laminate
4	1/8"x3/4"x48" Main Spar Laminate	2	3/16"x1/2"x4-1/2" Spruce Spar Doubler	6	1/4"x1/4"x36" Fuselage Main Frame	1	1/4"x1/2"x 6" Tiller Bar Mount
1	3/8"x3/8"x36" Servo Rails, Elevator Joiner						
Die-Cut Popular Plywood (Lite-Ply)							
1	1/8"x8"x22" F-2, F-3, F-4, F-5, F-6, F-1, F-B, F-9, F-10	1	1/8"x8"x22" F-1A, PT-1, PB-1, Hatch Supports, Wing Center Sheeting	1	1/8"x8"x22" PT-2	2	1/8"x8"x22" PS-1
2	1/8"x9"x22" WTR, W-1A,.W-4A, SW-1, SW-2, SW-3	2	1/8"x6"x18" W-2, W-4 Wing Ribs	2	1/8"x9"x18" W-2, W-3, W-4 Wing Ribs	4	1/8"x12"x18" W-1, W-2, W-3, W-4 Wing Ribs
1	1/8"x7"x36" PS-2, PB-2, G-1, TM, TWM, F-6A, PF	1	1/8"x9-1/2"x36" SW-4 Shear Webs				
Die-Cut Birch Plywood							
1	1/16"x10-1/2"x7" Instrument Panel, JW-1, Dihedral Gauge, Wheel Pant Plates	1	3/32"x4-1/2"x9" DB-3, DB-4, Hold-Down Plates, L.G. Mount Plates	2	5/32"x7-1/2"x8" F-1	1	5/32"x2-1/2"x17" DB-1, DB-2
1	5/32"x10"x12" JW-2, JW-3, IW-1, IW-2						
Sawn Plywood							
12	1/8"x3/8"x10-1/2" LITE-PLY Rib Stiffeners	2	1/64"x5/8"x48" BIRCH PLYWOOD Wing Straps	2	3/32"x3"x4-1/4" BIRCH PLYWOOD Servo Access Hatches	2	1/8"x1"x6" BIRCH PLYWOOD PW
2	3/16"x1"x4" BIRCH PLYWOOD L.G. Block Doublers	2	1/4"x4-11/32"x1-5/16" BIRCH PLYWOOD JW-4				
Wire Parts							
1	3/32" dia. Straight Wire for Servo End of Elevator Pushrod	1	1/8" dia. Formed Top Shock Strut Wire	1	1/8" dia. Formed Bottom Shock Strut Wire	1	3/16" dia. Formed Front Main L.G. Wire
1	3/16" dia. Formed Rear Main L.G. Wire						
Plastic Parts							
1	Left Dummy Engine Cylinders	1	Right Dummy Engine Cylinders	1	Cylinder Shrouds	1	Fuel Cap Cover, Shock Spring Halves, Compass Halves
1	.030"x8-1/2"x17" Clear Butyrate for Windshield						
Fiberglass Parts							
1	Cowling	2	Wheel Pants - LEFT AND RIGHT ARE THE SAME	1	Left Wingtip	1	Right Wingtip
Miscellaneous Parts							
1	1/2" dia. x3 ft Green Foam Cockpit Coaming, Grooved	1	3/32" wide x7 ft Cockpit Lacing	1	32" long Fiberglass Pushrod Shaft (for elevator)	1	12"x19" 6 oz. Fiberglass Cloth (for L.G. & Wing Joint)
1	Small Nylon Tubing (for Rudder Cable Guides & Throttle Pushrod)	1	20" long Steel Cable (for throttle pushrod)	1	Full-Size Plans - Plate 1	1	Full-Size Plans - Plate 2
1	Full-Size Plans - Plate 3	1	Full-Size Plans - Plate 4	1	Decal Sheet	1	Instruction Book
Special Extruded Aluminum Parts							
2	2" long Rear Wing Joiner Channels	2	3" long Front Wing Joiner Channels	2	6" long Rear Wing Joiner Spars	2	9" long Front Wing Joiner Spars

Hardware Pack							
6	2-56 x1/2" Mounting Bolts (1 rudder control horn, 5 tail brace wires)	2	4-40 x3/8" Mounting Bolts (for elevator control horn)	8	4-40 x1/2" Mounting Bolts (for rear wing joiner channels)	8	4-40 x1" Mounting Bolts (for front wing joiner channels)
10	6-32 x3/4" Mounting Bolts (for wing joiner spars)	1	6-32 x1" Mounting Bolt (for tiller bar)	6	4-40 x3/8" Socket Head Bolts (set screws for wing joiner channels)	2	6-32 x3/8" Socket Head Bolts (set screws for wheel pant mounts)
4	10-32 x1" Socket Head Bolts (for engine mounts)	6	2-56 Hex Nuts (1 rudder control horn, 5 tail brace wires)	1	6-32 Hex Nut (for tiller bar)	8	4-40 Aircraft Lock Nuts (for front wing joiner channels)
10	6-32 Aircraft Lock Nuts (for wing joiner spars)	10	4-40 Blind Nuts (8 for rear wing joiner channels, 2 for elevator horn)	4	10-32 Blind Nuts (for engine mounts)	8	#4 Flat Metal Washers (for front wing joiner channels)
12	#6 Flat Metal Washers (2 for tiller bar, 10 for wing joiner spars)	2	#8 Flat Metal Washers (for wheel spacers)	8	#2 x3/8" Sheet Metal Screws (for servo access hatches)	10	#2 x1/2" Sheet Metal Screws (6 for cowl, 4 for tail brace wires)
4	#4 x3/8" Sheet Metal Screws (for wheel pant mounts)	8	#4 x1/2" Sheet Metal Screws (for I.g. straps)	2	1/4-20 x1-1/2" Molded Nylon Bolts (for wing attachment)	1	Molded Nylon Tiller Bar
2	3/16" I.D. Molded Nylon Wheel Pant Mounts; with Brass Inserts	1	Extra Large Molded Nylon Control Horn (for elevator)	1	Molded Nylon Rudder Control Horn	2	90deg. Molded Nylon Bellcranks (for aileron control horns)
4	Large Molded Nylon Landing Gear Straps	4	4-40 x8" Threaded Rods (2 aileron, 1 elevator, 1 rudder)	4	4-40 Metal RIC Links (2 aileron, 1 elevator, 1 rudder)	3	4-40 Solder Links (2 aileron, 1 elevator)
3	2-56 Nylon R/C Links (2 rudder, 1 throttle)	1	2-56 Solder Link (for throttle pushrod)	1	2-56 Threaded Coupler (for throttle pushrod)	2	3/16" Wheel Collars (for main landing gear)
2	6-32 Headless Set Screws (for 3/16" wheel collars)	14	Steel Brace Wire Attach Tabs	10	3/32" O.D. x1/2" long Aluminum Tubing, (for tail brace wires)	1	.027 x200" roll Steel C/L Cable (for rudder control and tail brace wires)
1	roll - Soft Copper Wire (approx. 21 ft.)	15	Giant Size XX Molded Nylon Hinges	15	Steel Pins (for Hinges)	1	Tailwheel Assembly (bagged separately)

NOTE: All of the hardware for the aluminum wing joiners is packed with the aluminum parts in a separate bag.

Glues

There are many different glues available today for model construction that it can be confusing to even the experienced modeler. To simplify matters, most glues can be classified as one of four types:

1. Fast cyanoacrylate adhesives (abbreviated as C/A) such as Sig CA, Hot Stuff, Jet etc.
2. Easy to use water-based wood glues such as Sig-Bond (yellow) and Sig Super-Weld (white).
3. Super strong (but heavier) two-part epoxy glues such as Sig Kwik-Set (5 minute cure) and Sig Epoxy (3 hour cure).
4. Traditional solvent-base model cements such as Sig-Ment.

Each of these types has different characteristics and advantages. Often times, the choice of which type to use is strictly a matter of personal preference based on your experience with a previous model. To help speed up assembly, C/A glue is recommended for general construction. You should also have on hand some epoxy (both 5 min. and slow dry) and Sig-Bond because these glues are called out in several places in these instructions.

Sig CA, like most brands of cyanoacrylates, come in three viscosities- thin, medium, and thick. An accelerator spray and debonder are also available and are described below.

- **Sig CA Thin** - Watery consistency, thin CA should only be used when the two parts to be joined are in perfect contact with zero gap. Capillary action pulls this glue deep into the wood resulting in a very strong bond and it dries in just a few seconds. Thin CA can be used to tack assemblies together, but these joints should be glued again later with medium or thick CA.
- **Sig CA Medium** - Our medium thickness CA is excellent for almost any step during construction. The extra thickness allows the glue to fill small gaps, but it does dry a little slower than a thin CA. If you want only one type of C/A, use medium thickness.
- **Sig CA Slow** - This thickest formula is good for filling large gaps and building up strong fillets at joints requiring extra strength. It also dries slow enough to allow you to apply it to one part and position it on another before it dries. (With the thin and medium C/A's, the parts must be in contact and positioned correctly before glue application.) This feature is useful when laminating large sheeted areas like a fuselage side and a fuselage doubler.
- **Sig Kwik-Shot Accelerator** - Spraying accelerator on CA (any thickness) will cure it almost instantly. Although CA is fast, it's sometimes nice to speed it up even more.
- **Debonder** - This can be used to separate parts, but you'll probably use it for unsticking your fingers more than anything else!

CAUTION: Some people have experienced allergic reactions when exposed to epoxy or cyanoacrylate glues. This is very rare. However, it is extremely important that such glues, and also paints, thinners and solvents, be used with adequate ventilation to carry fumes away.

Notes Before Beginning Construction

Any references to right or left refers to your right or left as if you were seated in the cockpit.

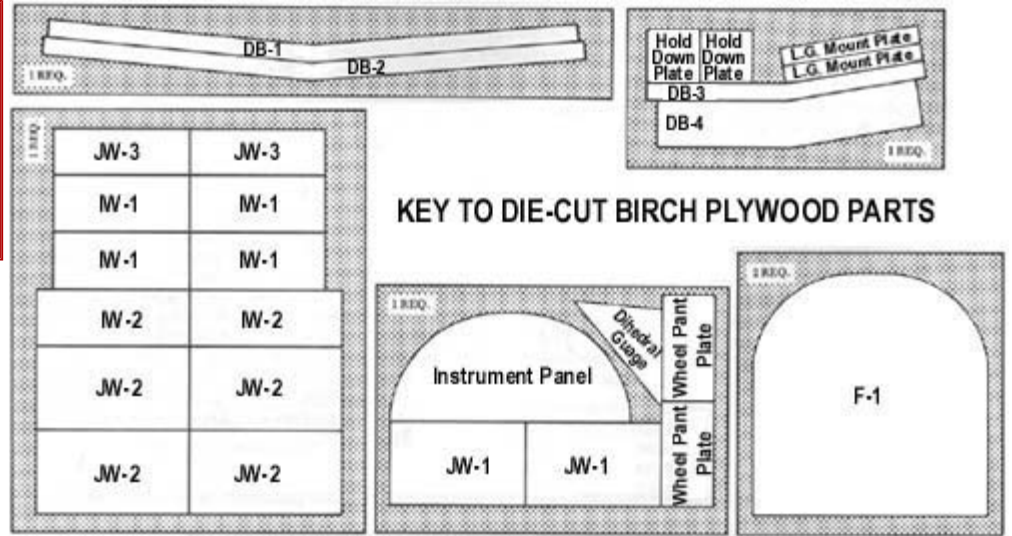

To build good flying models, you need a good straight building board. Crooked models don't fly well! The building board can be a table, a workbench, a reject "door core" from the lumber yard, or whatever- as long as it is perfectly flat and untwisted. A 2ft.x6ft. board is recommended for the Spacewalker.

Cover the top surface of the building board with a piece of celotex-type wall board or foam board, into which pins can be easily pushed. Don't hesitate to use plenty of pins during assembly to hold drying parts in their correct position.

When pinning or gluing parts directly over the full-size plans, cover the plan with wax paper or plastic kitchen wrap to prevent gluing the parts to the plans.

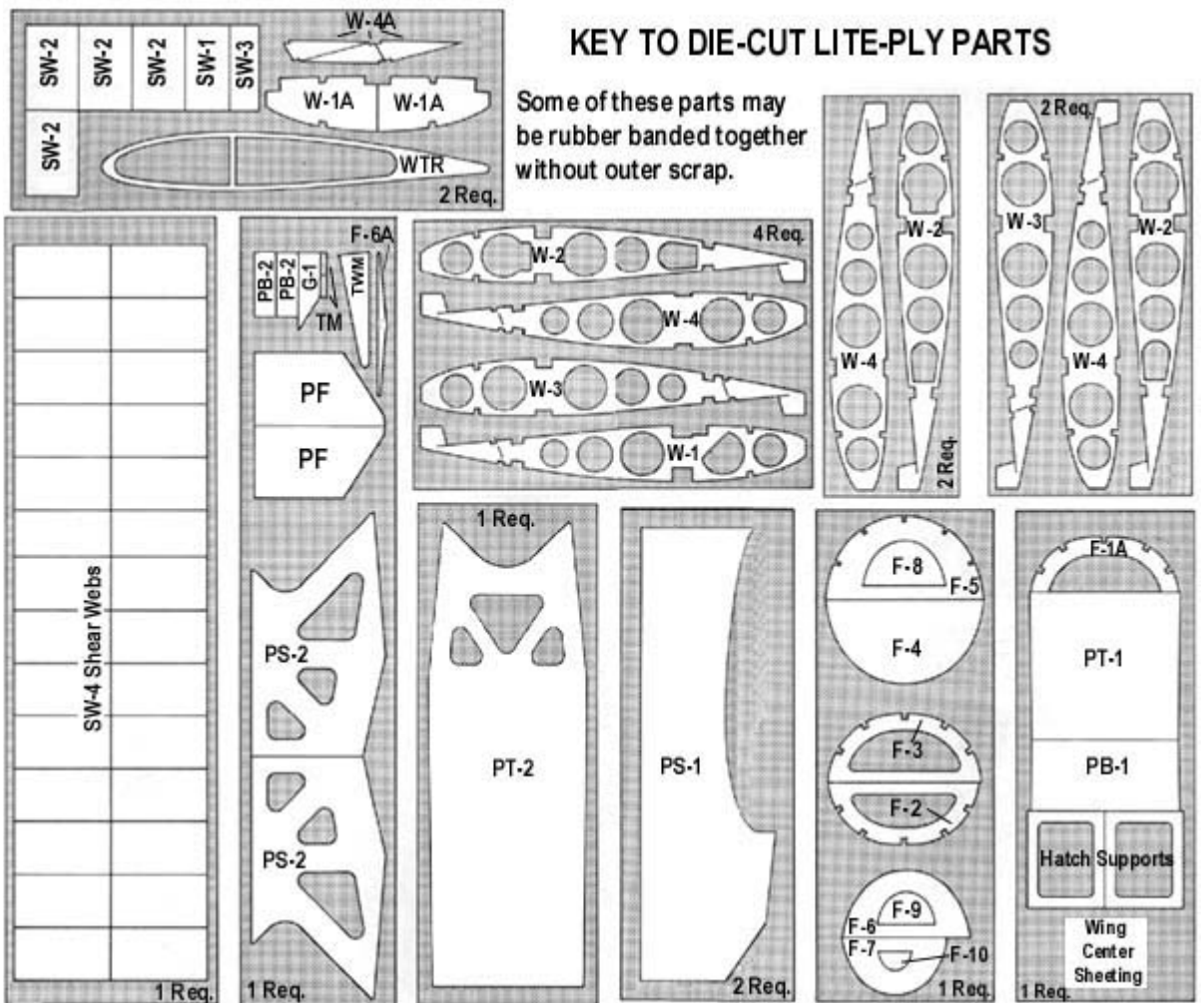

The balsa die-cut parts have identification numbers printed on them. The plywood die-cut parts do not. Use the "Key to Die-Cut Birch Plywood Parts" and the "Key to Die-Cut Lite-Ply Parts", to mark the identification numbers on the corresponding plywood and Lite-Ply parts.

Leave all the die-cut parts in the sheets until needed for construction. Remove pieces from the sheets carefully. If difficulty is encountered, do not force the part from the sheet. Use a modeling knife to cut it free.

All of the other kit parts can be identified by the "Complete Kit Parts List". Sort the different sizes of sticks and sheets into individual piles to avoid confusion during building. Cut all long pieces of balsa first, followed by medium lengths, before cutting up any full length strips into short pieces.

YOU CAN'T GET ALONG WITHOUT A GOOD SANDING BLOCK

An assortment of different size sanding blocks are indispensable tools for model construction. A good general purpose block can be made by wrapping a 9"x11" sheet of sandpaper around a piece of hardwood or plywood. Use three screws along one edge to hold the overlapped ends of the sandpaper. Put 80-grit paper on the block during general construction. Switch to 220-grit paper for final finish sanding just before covering.

Another handy block can be made by gluing sandpaper onto a 24" or 36" long piece of aluminum channel stock. Most hardware stores carry a rack of aluminum in various sizes and shapes. This long block is very useful for sanding leading and trailing edges accurately.

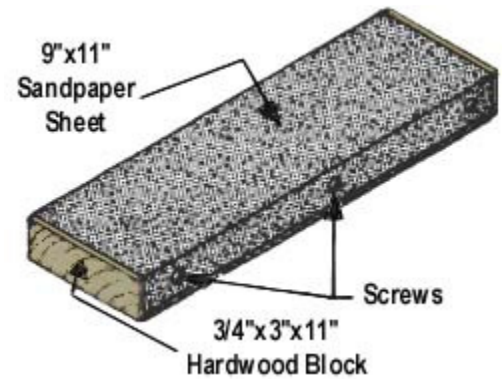

About The Building Sequence

The quickest and most efficient way to complete a model is to work on several pieces at the same time. While the glue is drying on one section, you can start on or proceed with another part. Work can even go forward on several sections of the same assembly at the same time, such as the front and rear sections of the fuselage. Keep in mind that the numbering sequence used in these instructions was chosen as the best way to explain the building of each major component and is not intended to be followed exact one-two-three fashion. Start on the wing at No.1 and after doing as many steps as is convenient, flip over to "Fuselage Construction" and do a step or two or three, then over to "Tail Surface Construction" and so forth. You will, of course, arrive at points where you can go no farther until another component is available. For example, you need a nearly completed wing before the fuselage can be entirely completed. Plan ahead! Read the instructions completely and study the full size plans before beginning construction.

Radio Requirements

You will need at least a four-channel radio system for your Spacewalker to operate the ailerons, elevator, rudder and throttle. Heavy-duty servos intended for use on 1/4-scale models are required for all of the flight controls. Also, use a receiver battery with at least a 1000mA capacity to power those servos for a safe amount of time. Be certain that your radio system's frequency is approved for use in R/C model aircraft. Using a frequency assigned to R/C model cars not only endangers your model to interference from model car drivers (who may not be in sight), it also is against the law.

About Printed Wood Parts

To answer the question we are sometimes asked - no, we do not print parts on wood to save money. It is actually more expensive to print the parts using a silk screen press than it is to run an equivalent sheet through our automatic feed die cutting machine. If we hand-sawed the parts it would be even more expensive and the labor cost would have to be added to the kit price. We believe that most modelers would rather cut their own out and save the cost. Since there are not many thick parts in our average kit, it really doesn't consume a lot of the total building time for the builder to do the parts.

WING CONSTRUCTION

The Spacewalker has a wing designed with removable outer panels so that it can be "broken down" into three easily-managed pieces for transporting. The outer panels are joined to the center section using extruded aluminum wing joiners and are held in place by three set screws on each side. The following instructions are strictly for the three-piece wing as shown on the plans.

Some modelers may prefer to build the wing as a one-piece unit. This will save about a pound in weight (through the omission of all the wingjoining hardware), but will require a full-size van or model trailer to transport the model. If you wish to build a one-piece wing instead of the standard three-piece wing, please read and follow the instructions concerning "How to Build a One-Piece Wing", included at the end of the Wing Construction Section. You should also read "About the Ailerons", included further on, before beginning work on the wing.

Notice that a nearly completed wing assembly is needed to complete construction on the fuselage. It is recommended that you begin to build the wing first so that it will be ready when you reach that point in the fuselage instructions.

Wing Subassemblies

Before beginning construction on the wing, there are a number of subassemblies that should be built and set aside until needed. This is done to avoid interruptions during the flow of the wing construction.

1. The main wing spars are laminated from 1/8"x3/4" spruce sticks as shown in the "Main Spar Assembly Diagram" on the plans (Plate 3). Build four main spars using a thin film of slow-drying epoxy to join each laminate. It is very important that the main spar assemblies be kept perfectly straight while drying. Any 'bends or twists built in now are there to stay!
2. Join two die-cut 1/8" lite-ply W-IA sub-ribs to two W-I wing ribs, being certain to make one left and one right. These subassemblies will serve as the two center ribs in the wing center section. The remaining two W-IA sub-ribs are not installed until the wing has been fitted to the fuselage.
3. Use scrap pieces of 1/16" balsa to join together two W-2 wing ribs. Make two of these subassemblies. These are the two ribs that will meet at the wing joint when the outer panel slides in place. The 1/16" balsa scraps serve as temporary spacers that hold the ribs in perfect alignment. After construction, the spacers are cut away, so locate them around the edges where it will be easy to get at them.
4.
 - a. Again, use scrap pieces of 1/16" balsa to join two W-4A sub-ribs to two W-3 wing ribs, being certain to make one left-hand and one righthand. These subassemblies are used at the inboard ends of the ailerons.
 - b. Use scrap pieces of 1/16" balsa to join W-4A sub-ribs to two W-4 wing ribs. Make one left-hand and one right-hand. These subassemblies are used at the outboard ends of each aileron.

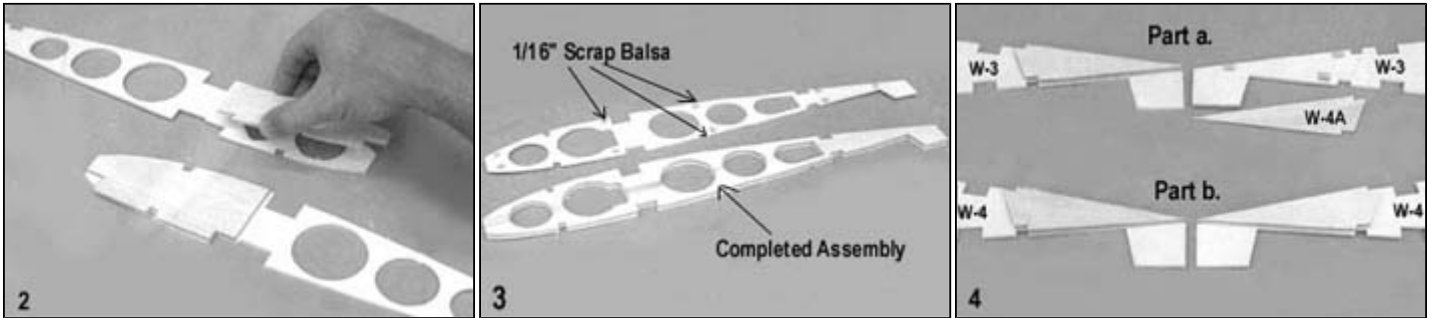

5. Prepare the aluminum wing joiner channels and wing joiner spars as shown in the diagrams below.

Carefully cut out the templates and accurately position them on the backs of the aluminum joiner channels. Use a punch to mark the channels

at the center of each hole. Remove the templates, and drill carefully and slowly at the punch marks. Drill all holes with #33 drill bit and use a drill press if at all possible.

ALUMINUM JOINER CHANNEL DRILLING TEMPLATES

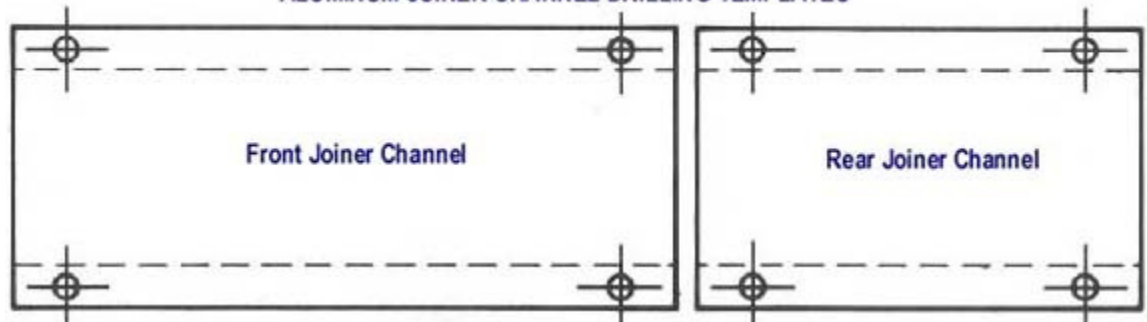

FRONT JOINER SPAR

9" Long, 2 Required

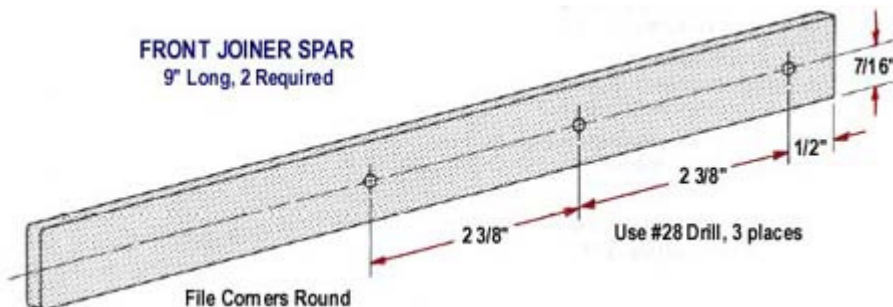

FRONT JOINER CHANNEL

3" Long, 2 Required

Drill and Tap for 4-40 Bolt
2 places. (Use #44 Drill)



File or sand all edges smooth.

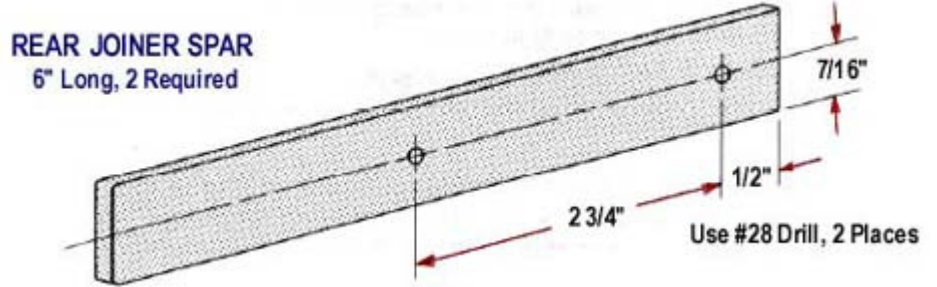
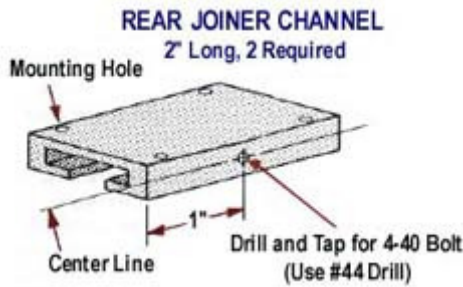

6. Epoxy together two die-cut 5/32" plywood IW-1 inner webs and use a weight to hold them flat while drying.

7. Glue the 3/16"x1"x4" plywood landing gear block doublers to the tops of the front landing gear blocks.

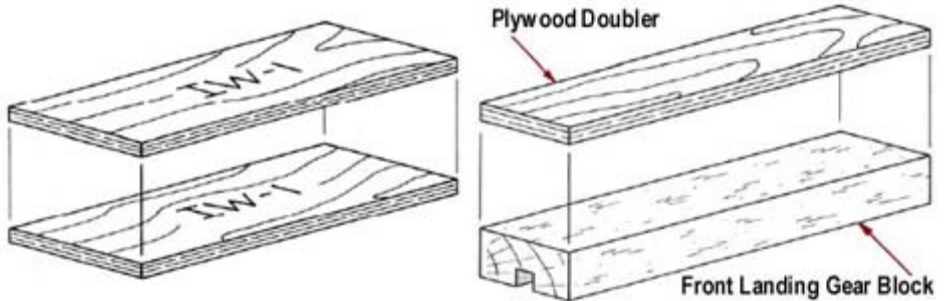

Wing Construction

The wing is built in two halves, each consisting of an outer panel and half of the center section. After construction, the outer panels are cut free and the center section halves are joined to complete the three-piece wing.

8.
 - a. Pin down one of the laminated spruce main spars over the plans.
 - b. Glue and pin all of the 1/8" lite-ply wing ribs into position except for the W-1/W-1A subassembly at the wing center. Be sure to use the wing rib subassemblies that you prepared earlier in steps 3 and 4.

NOTE: The large lite-ply ribs may have a tendency to warp, making it difficult to align them on the plans at this time. To counteract this, be sure to pin each rib accurately at the rib alignment tabs. Then, as each spar or leading edge piece is added, gently pull each rib into position while gluing. By the time you have added the front spars, the rear spars, and the leading edges, the ribs should all be perfectly straight.

9. Glue another laminated spruce main spar assembly to the tops of the ribs. Use a builder's triangle to make certain each rib is vertical.
10. Locate the die-cut 1/16" plywood dihedral gauge. Position the W-1/W-1A wing rib subassembly in its position on the plans using the dihedral gauge to insure that it is at the proper dihedral angle. Glue the rib assembly to the spars.

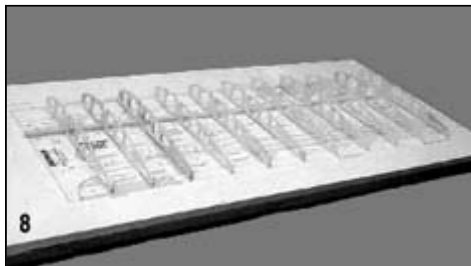

BUILDER'S TIP:

Glue scrap pieces of 1/4" sq. balsa to the sides of the rib alignment tabs to accept pins. It's a lot easier to pin through balsa than lite-ply!

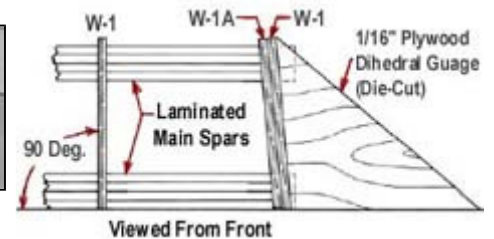

11.
 - a. Cut a 1/4" sq. x12" balsa forward spar from one of the 36" lengths provided. Glue this spar to the top of the center section ribs. The outboard end of this spar should be positioned about halfway between the two W-2 ribs at the wing joint.
 - b. Glue a 1/4" sq. x 36" balsa forward spar into position on top of the outer panel wing ribs with its inboard end butted against, but not glued, to the center section forward spar.
12.
 - a. Cut a 1/8"x3/4"x12" balsa leading edge for the center section and glue it in place at the front of the ribs, again placing the outboard end between the two W-2 ribs at the wing joint.
 - b. Add the 1/8"x3/4"x36" balsa leading edge to the outer panel.

13.
 - a. Cut a 1/4"x1/2"x12" balsa rear spar from one of the 36" lengths provided and glue it to the top of the center section ribs.
 - b. Glue a 1/4"x1/2"x36" balsa rear spar in position on top of the outer panel wing ribs. This spar should butt up against the center section rear spar at the wing joint, but should not be glued to it.
 - c. Repeat parts a. and b. of this step for the bottom rear spar. You will have to slide the spars under the ribs, then lift them into position.

14.
 - a. Cut a twelve-inch length of 3/32"x1-1/2" balsa from one of the 30" lengths provided (not one of the 36" pieces!) to serve as the center section trailing edge sheeting. Glue it in place on top of the center section wing ribs. Careful! Make sure that the back edge of the sheet is in the right place, directly above the trailing edge on the drawing.
 - b. Glue the 3/32"x1-1/2"x36" balsa trailing edge in place on the outer panel, again being careful to check for the correct overhang.

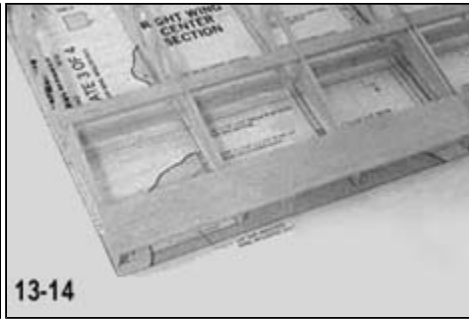
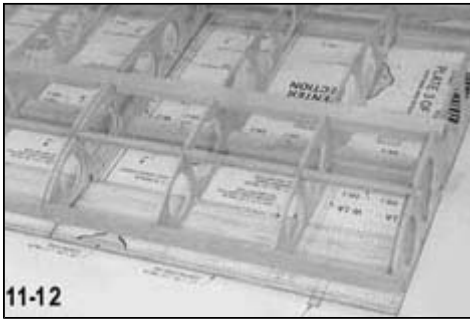

Wing Joiner Assemblies

15.
 - a. Trial fit an IW-1 inner web subassembly (from Step 6.) in its position between the spars and trim as necessary, but do not glue it in place. Also, trial fit a die-cut 1/16" plywood JW-1 joiner web and, again, trim as necessary.
 - b. Epoxy the IW-1 subassembly to the JW-1 joiner web as shown in the diagram. Wipe away any excess epoxy before it dries.
 - c. Trial fit the die-cut 5/32" plywood IW-2 and JW-2 webs as you did before. Epoxy the pieces together as shown in the diagram. Notice that only the JW-2 joiner web closest to the wing joint has an IW-2 inner web glued to it. The outboard JW-2 web should also be fitted in position, but not glued.

16.
 - a. Insert one end of a front wing joiner spar into a front wing joiner channel so that it is flush with one end of the channel. Tighten the socket-head set screws snugly against the joiner spar. **IMPORTANT:** To avoid any misalignment later on, it is important that the set screws be tight while installing the aluminum wing joiner assembly.
 - b. When dry, place the joiner webs in their position in the wing to check that they still fit, but don't glue.
 - c. Position the wing joiner assembly on the joiner webs and clamp it in place. The assembly should be centered between and parallel to the spars. When satisfied that it is positioned correctly, mark JW-1 and JW-2 at the drill holes. Remove the clamps, wing joiner assembly, and joiner webs from the wing.

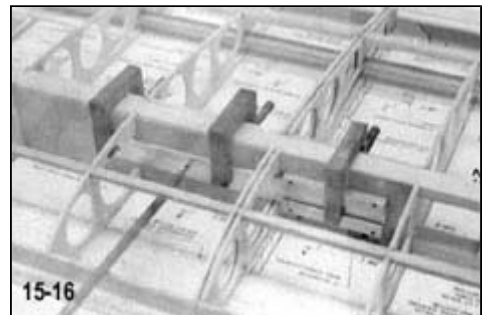
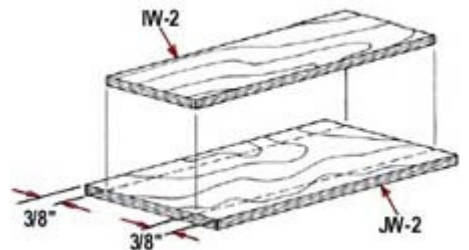
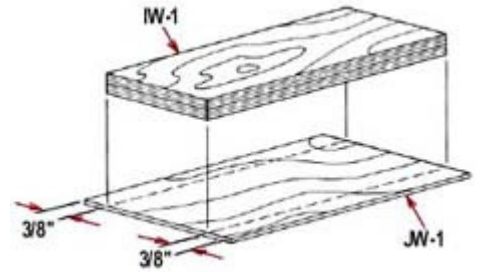

BUILDER'S TIP: Scrap pieces of plywood placed against the back side of the spars provide a convenient surface for the clamps used in this step.

17.
 - a. Accurately drill JW-1 at the marks with a 3/32" drill bit and the JW-2 pieces at the marks with a 1/8" drill bit. Reinstall the joiner webs in the wing again, but do not glue.
 - b. Bolt the aluminum wing joiner assembly in place using the hardware as indicated on the plan (Plate 3, see "Section A-A" and "B-B").
 - c. When you are satisfied that the joiner webs and the aluminum wing joiners are fastened correctly, pull the whole works away from the spar. Spread epoxy over the back of the joiner webs where they contact the spar, then clamp them in place (being careful not to glue together the aluminum pieces). When dry, give the joiner webs and inner webs a generous coating of epoxy from the backside to insure a solid glue joint.

18.
 - a. Assemble a rear wing joiner channel and rear wing joiner spar and tighten the set screw.
 - b. Lightly sand the front face of the rear spars where the joiner webs sit, just enough to provide a flat gluing surface.
 - c. Pin or tape JW-3 and JW-4 in place, then clamp the rear wing joiner assembly on top of them. Carefully line-up the aluminum joiner so that it is parallel with the front joiner, and mark the positions of the drill holes. Remove the joiners and the webs from the wing.
 - d. Carefully drill JW-3 with a 5/32" drill bit and JW-4 with a 1/8" drill bit. Bolt the wing joiner assembly on the joiner webs and make certain that it all still fits in the wing. Notice that the rear spar will have to be relieved slightly in spots to accept the blind nuts on the back of JW-3. When satisfied with the fit, epoxy the joiner webs to the front face of the rear spars.

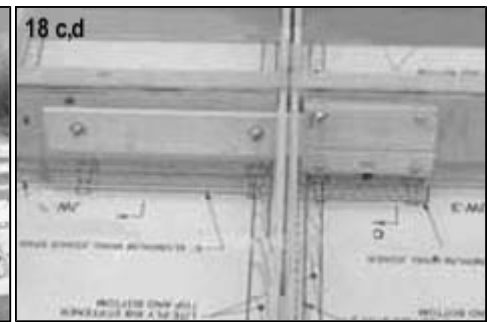
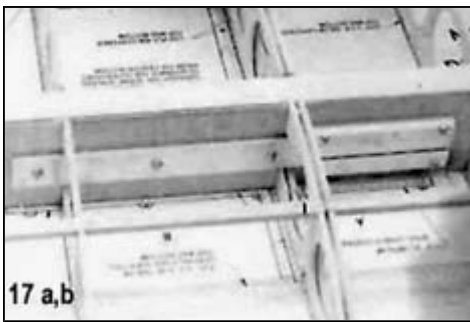

19.
 - a. Trim the die-cut SW-1 shear web to fit between the two W-1 wing ribs. Notice that the bottom edge of this shear web is even with the top of the cutout for the landing gear block in W-1A.
 - b. Glue a die-cut SW-2 shear web in place on the front of the spars. (No shear webs should be installed on the backside of the spars now because you will need to get at the pins in the bottom spar when it is time to remove the wing from the building board.)
 - c. Lightly sand flat spots on the front of the rear spars (as you did before) where the SW-3 shear web and DB-4 dihedral brace are located, then glue SW-3 in place. DB-4 will be glued in later.
 - d. Glue the die-cut SW-4 shear webs to the front of the main spars in the outer panel.

20.
 - a. Sand the top of the leading edge to the contour of the ribs. Be careful to avoid sanding the ribs and changing their shape.
 - b. The leading edge is sheathed with 3/32"x3"x12" balsa on the center section (cut from 30" material) and 3/32" x 3" x 36" balsa on the outer panels. The sheathing should overlap onto the forward spars only about halfway. Start gluing at the spars and work forward to the leading edge, pinning or taping the sheets in place as you go. There will be excess sheathing forward of the leading edge.

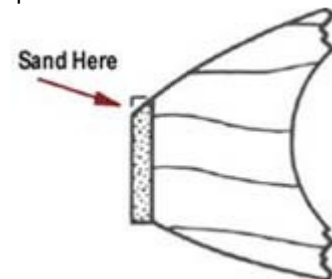

21. Fill the gap at each W-2, W-3 and W-4 rib above the main spar with spacers made of short lengths of 1/8" sq. balsa. When dry, sand the spacers down even with the tops of the ribs.

22. Trim the 3/16"x1/2"x4-1/2" spruce spar doubler to fit between the ribs as shown on the plan. Glue this piece to the bottom spar only. This doubler is there to reinforce the weak point in the spar when a relief is cut in it later to pass the aileron pushrod.

23. Cut two 1/8"x1/4" balsa aileron spars to the correct length and glue them to the wing, one on top and one on bottom.



24. Use a 3/32"x2"x36" balsa sheet for the top aileron sheathing (save the excess for later). Glue this sheet to the top of the wing as shown. This sheet will eventually be sliced down its length when the aileron is cut from the wing.

25. Glue the 3/32"x1/4" capstrips to the tops of the wing ribs and aileron ribs as indicated on the plan. When dry, remove the wing from the building board.

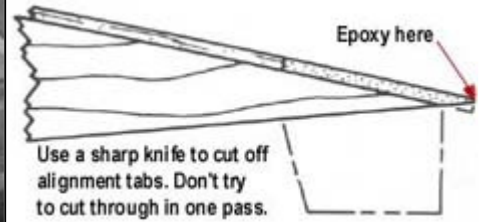
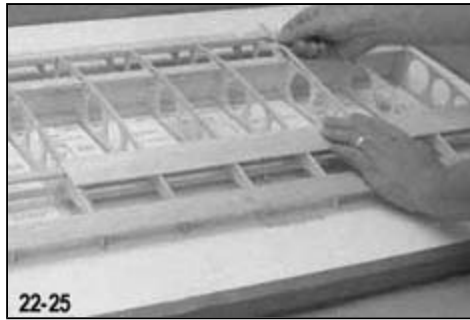

26. Glue in the remaining SW-4 shear webs on the back of the main spar.

BUILDER'S TIP :

Now is a good time to look over your basic wing structure for any joints that may need another coat of glue. In particular, inspect the bond at all the rib, spar, and web joints.

27. a. Carefully cut away all of the rib alignment tabs, then sand the bottom of the ribs and the rear edge of the trailing edge sheeting to the airfoil shape.
 b. Glue the 3/32"x1-1/2" balsa trailing edge sheeting to the bottom of the wing. Use epoxy glue where the bottom sheeting joins the top sheeting. The epoxy will not warp the trailing edge (as water-based glues might) and will strengthen the sharp edge so that it is not so easily damaged.

28. a. Notch the bottom trailing edge sheeting in the position shown on the plans for the die-cut 3/32" plywood wing hold-down plate.
 b. Cut the 1/2"x1-1/2" special-cut balsa trailing edge fill-in block to fit between the W-1 ribs and glue it in place.
 c. Glue the wing hold-down plate to the fill-in block at the notch that you made in "part a" of this step.

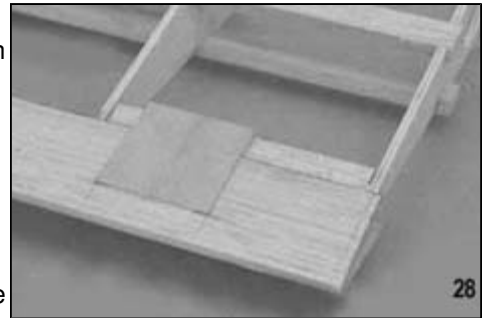

29. a. Add the 1/4' sq. balsa forward spars to the bottom of the wing.
 b. Sand the leading edge to the bottom contour of the wing as you did in Step 20.
 c. Glue the 3/32"x3" balsa bottom leading edge sheeting in place in the same manner as the top leading edge sheeting. Notice that the center section sheeting must be cut about an inch short at the inboard end. Later, this sheeting will be cut away even further.
 d. When dry, trim the excess top and bottom sheeting flush with the front of the leading edge.

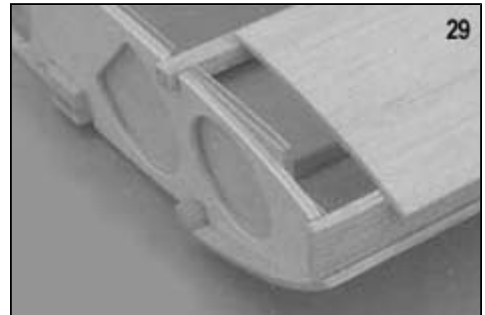

30. a. Glue the 1/4"x7/8" balsa leading edge caps to the front of the wing. (Cut the 12" center section cap from a 36" length.) Use tape or pins to hold the leading edge caps flat. Let dry.
 b. Carve and sand the leading edge caps to the shape shown on the plans. Take your time with this step and try to keep the shape uniform along the entire leading edge. You can use the optional Leading Edge Carving Guide (Plate 3) to check the shape at random spots along the leading edge.

31. a. Add the 3/32"x1" balsa bottom wing sheeting.
 b. Add the 3/32"x3/4" balsa bottom aileron sheeting.
 c. Use the leftover material from Step 24. for the servo bay sheeting. Make the pushrod exit cutout as shown on the plans then glue this sheeting to the bottom wing surface only.
 d. Glue in all the 3/32"x1/4" balsa capstrips on the wing bottom.

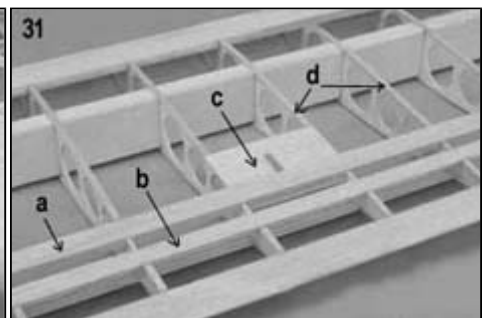

32. Carefully sand the entire wing half until all joints are smooth. Use a large sanding block to avoid sanding down anyone area too much.
33. Use a deep blade razor saw (such as an X-Acto No. 236) to cut through the top and bottom main wing spars and the temporary balsa spacers at the wing joint.
CAUTION: BE VERY CAREFUL NOT TO CUT OR EVEN NICK THE ALUMINUM JOINER SPAR DURING THIS STEP. Even a very small nick in the joiner at this spot may become the starting point for a stress crack that could lead to a structural failure of the spar.
 You may now loosen the set screws in the wing joiner channels and remove the outer panel from the center section half. Reassemble the wing parts to check for smooth operation of the joiner assemblies. Any binding or misalignment must be corrected before proceeding.
34. Repeat Steps 8 through 33 for the opposite wing half.

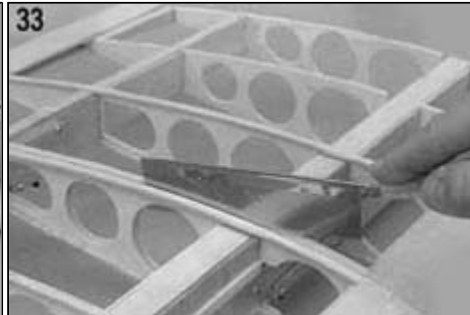
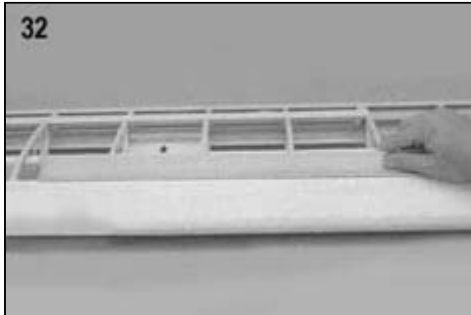

BUILDER'S TIP: Although it's not shown on the plans, we recommend that you install scrap pieces of lite-ply above and below the front wing joiner channel and joiner spar. This will prevent any possible movement of the aluminum parts.

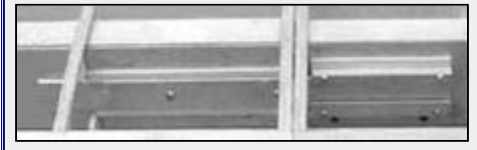

Completing The Wing Center Section

The center section may at first appear to be overly complex or "overbuilt". You should remember, though, that it not only has to withstand the airloads from its nine-foot wing, it must also bear the brunt of the landing loads. Many of the following steps are required to make the landing gear attachment as safe, strong, and scale as possible.

35. a. Sand the inboard and outboard ends of the center section halves bringing the spars, leading edges, and trailing edges flush with the end ribs. Trial fit the center section halves together with the die-cut 5/32" plywood DB-1 and DB-2 dihedral braces. The center ribs should meet flush when the dihedral braces are clamped in place temporarily. The long dihedral braces will automatically set the proper dihedral.
- b. Use slow-drying epoxy glue to join the two center section halves, DB-1, and DB-2. Hold everything in place with clamps until dry. Try for good joints and don't be stingy with the glue during this step! Before it dries, double check that the two halves are aligned perfectly with each other.
36. a. Glue the SW-2shear webs to the back of the spar and dihedral braces to finish "boxing off" the spar.
- b. Add the 1/8" sq. balsa spacers to the top spar at the W-1 ribs.
37. Install the top center sheeting using pieces cut from the 3/32"x3"x30" balsa sheet provided (don't sheet the bottom yet).
38. a. Use a razor saw to cut a 3/32" wide slot in the center ribs, just forward of the rear spars, to accept the die-cut plywood DB-4 dihedral brace.
- b. Trial fit DB-4 and trim to size, if necessary. Epoxy DB-4 to the rear spars and the ribs, again using clamps to hold it in place until dry.

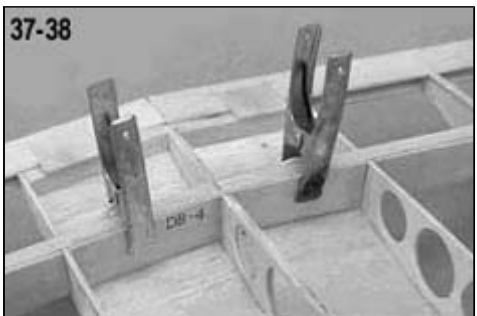

REFER NOW TO THE FUSELAGE INSTRUCTIONS, STEP 85, BEFORE PROCEEDING. Several steps in the fuselage instructions actually involve work on the wing center section. Construction must be completed through Step 91 before continuing in this section.

- 39.
- Fit the basswood rear landing gear blocks to the wing by beveling the ends to match at the center where they meet. You will have to cut away part of the SW-2 shear webs that interfere with the blocks. Glue the blocks in place.
 - Epoxy the die-cut DB-3 dihedral brace to the front of the rear l.g. blocks. Clamp in place until dry.
 - Reinforce each rear l.g. block with short lengths of 3/4" balsa triangle stock glued to the top of the blocks and SW-1.
 - Add the die-cut 3/32" x 1/2" x 4" plywood l.g. mount plate to the wing. These plates provide a solid base for the nylon l.g. straps, and should be flush with the surface of the rear l.g. blocks. See the "Wing Rib Cross Section" at W-1 (Plate 3) for more clarity on their position.

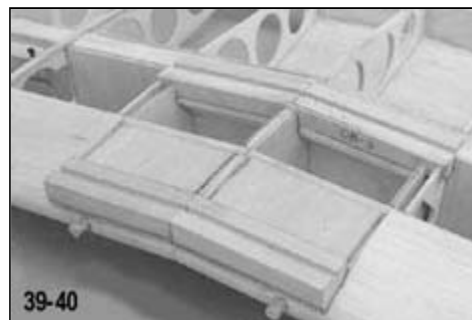

- 40.
- Carefully trim the wing leading edge flush with the support blocks to make a seat for the front landing gear block assemblies.
 - Cut away the exposed portion of the two center W-1 ribs so that they are even with the front notches in the W-1A sub-ribs.
 - Trim the front landing gear block assemblies so that their inner ends meet at the center with the proper dihedral angle and the outer ends are flush with the W-1A sub-ribs. The l.g. blocks must sit firmly in the W-1A front notches and should also sit flat against the support blocks and leading edge. Epoxy the blocks in place, being sure to use plenty of glue.
 - Fit the 1/2"x3-1/4"x2" balsa landing gear support blocks between the front l.g. blocks and the forward spar. Glue them in place so that their surfaces are flush with the bottom edges of the W-1A ribs.



- 41.
- Cut out the bottom center sheeting that fits between the front l.g. blocks and DB-3 from scrap 1/8" lite-ply and glue in place.
 - Add the 3/32" balsa center sheeting to the bottom of the center section.
 - Glue scraps of 3/32" balsa to the sides of the W-1A sub-ribs to finish off the bottom center sheeting.



42. Strips of 1/8"x3/8"x10-1/2" lite-ply are provided for stiffening the ribs at the wing joint. This is necessary to keep the ribs from bowing inwards when the covering material is applied and shrunk tight. Cut the rib stiffeners to length and glue them to the ribs, just below the capstrips. See the "Wing Rib Cross Section" at W-2 (Plate 3) for the exact positioning of the stiffeners.
43. Cut two 2"x19" strips of heavyweight fiberglass cloth from the material provided. (Save the rest of the fiberglass cloth for covering the landing gear fairings.) Apply the strips to the top and bottom of the center wing joint using slow-drying epoxy. You should cut the bottom strip into two pieces to avoid the slots for the landing gear wires. To apply the strips:
- Coat the wing center with slow-drying epoxy.
 - Lay the fiberglass strip on top of the glue.
 - Holding one end of the strip so it won't move, "squeegee" the glue through the tape with a small paddle of scrap balsa. Scrape over the tape several times with the paddle to smooth the tape and remove the excess glue.
 - When dry, sand lightly to remove any rough spots, being careful not to sand into the fiberglass cloth itself.

Finishing The Outer Wing Panels

- 44.
- The die-cut 1/8" lite-ply hatch support fits under the edge of the capstrips and overlaps the forward edge of the servo bay sheeting 1/4". Glue the hatch support in place and add a 3/32"x1/4" balsa strip on the front edge so the covering material has a place to attach.
 - Trim the 3/32"x3"x4-1/4" plywood servo access hatch as necessary to fit snugly over the hatch support. Drill 1/16" dia. holes through the corners of the hatch into the hatch support. The hatch is held on with four #2 x3/8" sheet metal screws. Be sure to mark each hatch so you can tell later which hatch goes with which wing!

45. a. Glue in the 1/8"x3/8" lite-ply rib stiffeners. Don't forget the short pieces just inboard of the aileron.
 b. Sand down the inboard end of the wing panel bringing the spars, leading edge, and trailing edge flush with the side of the W-2 rib.

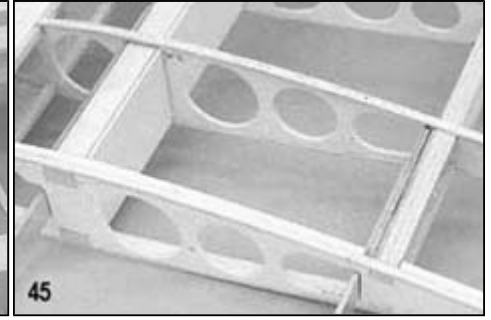
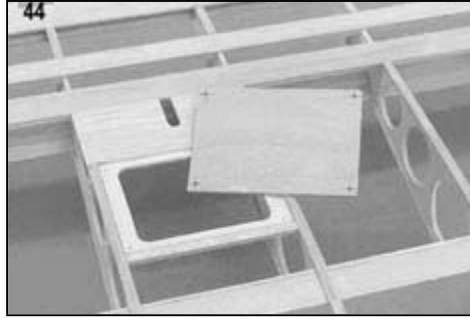

46. Saw out the aileron using a razor saw to cut through the ribs. Exactly where you cut is not too critical as long as it's somewhere between the rear spars and the aileron spars. Cut through the W-4 rib on the outboard end of the aileron, then remove and discard the part remaining attached to the aileron. The W-4A subrib will serve as the outboard edge of the aileron. Use a sharp modeling knife to cut the top aileron sheeting and the temporary spacers on the inboard end.

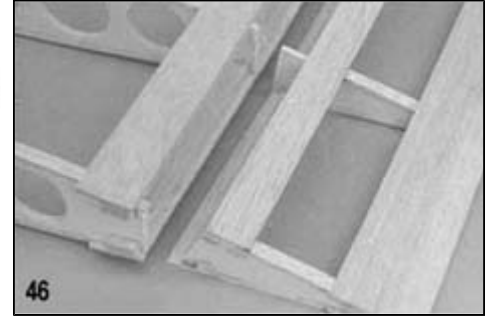
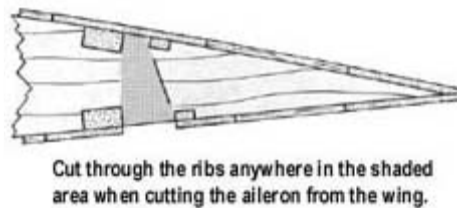

47. a. Trim and sand the back of the wing cutout until the ribs are even with the rear spars. Use a long sanding block to sand just enough to make the back edge flat, as shown here.
 b. Sheet the back of the wing cutout with 3/32" x 1-1/2" x 30" balsa, cut to length. When dry, trim the sheeting to airfoil contour.

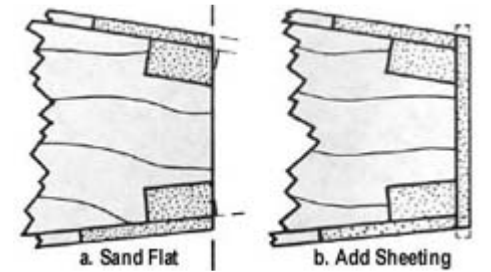

48. a. Sand the outer end of the wing panel, bringing all of the spars and sheeting flush with the end W-4 rib.
 b. Glue the die-cut lite-ply WTR wingtip rib to the end of the wing.
 c. The fiberglass wingtip can be glued to the wing using epoxy or CIA. Be sure to clean and lightly sand the inside of the fiberglass where the glue will come in contact. Notice that the wingtip overlaps only onto WTR when glued in place. Also notice that WTR does not extend all the way back to the rear point of the wingtip. The small gap that remains can be left as it is or filled with scrap balsa.
 d. Feather the wingtip into the wing using model filler.

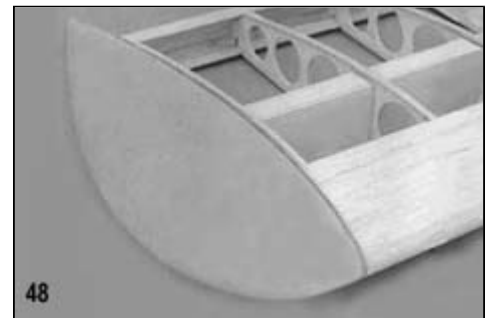

49. a. Trim and sand the front of the aileron in line with the angled, die-cut slits in the ribs.
 b. Add the 3/16" x 1-1/2" x 30" balsa aileron leading edge.
 c. When dry, sand the aileron leading edge to shape.
 d. Sand each end of the aileron flat.

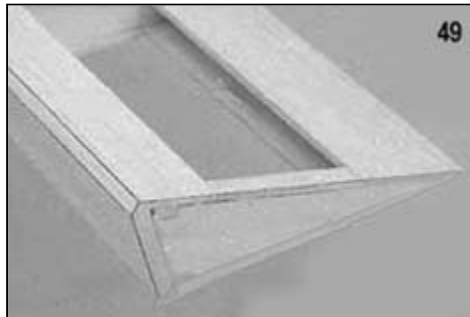

50. a. Glue in the W-4A aileron rib in the position shown on the plans. The aileron rib may need some trimming to slip into place.
 b. The aileron control horn is actually a 90-degree bellcrank. Cut a slot in the aileron leading edge (don't cut the spar!) just large enough for one arm of the horn, then epoxy the horn firmly in place on the W-4A rib. See the "Wing Rib Cross Section" at W-4 (Plate 3) to see exactly how the horn is positioned.

51. Cut hinge slots in the aileron leading edge and the wing cutout to accept the nylon hinges. (See "Hinging Tips" below.) Use four hinges per aileron, in the positions shown on the plans. Trial fit the hinges and aileron on the wing, without glue, to check for smooth operation and proper fit. If there is any mismatch or binding, alter the slots as necessary to correct. The ailerons may be hinged permanently now, or after covering and finishing, if you prefer. Notice that the aileron should be positioned on the wing so that it has an equal gap, about 1/8", at each end. The gap at the leading edge should be 1/16" or smaller.

52. Repeat Steps 44 through 51 for the other outer wing panel.

HOW TO BUILD A ONE-PIECE WING

In many ways, building the wing in one piece will simplify construction. The only drawback is handling and transporting that big "surf board!". Even the size of your workshop should be taken into consideration since you will need to flip the wing over, turn it around, fit it to the fuselage, and even set it aside many times while you work. Think ahead! Having made the decision to build the one-piece wing, it becomes obvious that all of the steps involving the aluminum wing joiners can be skipped over during construction. The other major changes are as follows:

- **DELETE STEP 3.** You won't need two W-2 wing ribs at the wing joint because the one-piece wing has no wing joints. When it comes time to place the ribs on the bottom main spar, install only the outboard W-2 rib at the joint.
- **MAINTAIN THE BOX SPAR.** Even though the aluminum pieces have been omitted, the main spars still require plywood shear webs at those locations. The JW-2 webs can be used, but the JW-1 webs will have to be replaced since they won't be long enough with the W-2 rib having been omitted. Use 1/8" lite-ply for the shear webs. The rear webs can be omitted completely.
- **SPLICETHE LEADING EDGE, SPARS AND SHEETING.** The laminated spruce main spars won't require splicing, but the other spars will. Glue the ends of the spars together and reinforce the joints by bridging them with scrap balsa. Place all of the splices for the spars and leading edges towards the outboard end of each wing half. The leading edge sheeting and trailing edge sheeting should be carefully cut and located so that the splices are centered over a wing rib.

ALTERNATE AILERON CONTROL HORN POSITION

By placing the control horn aft of the hinge line, the aileron will automatically have different movement; that is, it will hinge slightly further up than down. The further aft the horn, the more "differential". On an airplane like the Spacewalker, differential ailerons improve the quality of the turns in flight. The alternate aileron control horn position shown below will give more differential movement than the one shown on the plans, but it's not quite as sturdy. We recommend that you use the horn position shown here if you are building a wing with the "short" (four-bay) ailerons, since it will benefit more from the increased differential than will the longer aileron versions. Many of the new radio systems give the modeler the ability to adjust the aileron differential electronically, making the original horn position more desirable.

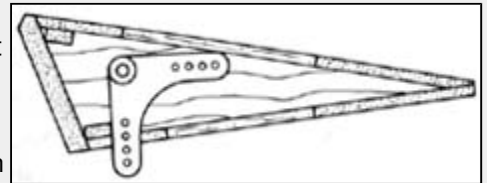

ABOUT THE AILERONS

One of the difficulties of modeling a homebuilt aircraft is trying to keep up with all of the changes that are inevitably made by the aircraft's owner or designer. In the case of the Spacewalker, the ailerons were the primary focus of early redesign. Jesse Anglin built the prototype Spacewalker (N107 JA) with ailerons that spanned the full length of the outer wing panels (eight rib bays). He apparently felt that the ailerons were too long, so he changed the design by cutting the aileron length in half (four rib bays), leaving the chord the same. All full-scale Spacewalker builders, including Maxey Hester of Sig, were notified of the change. Therefore, N107JA is the only example of this design to use eight-bay ailerons. Maxey flew his Spacewalker (N516MH) with the four-bay ailerons for the first time on September 4, 1987. Jesse Anglin was present that day at Sig Field and also took a turn at the stick. Mildly disappointed with the roll response of the short ailerons, Jesse decided later to make another design change: Split the difference! The six-bay aileron is now standard on the Spacewalker, even though none have been flown with that type of aileron. However, another full-scale Spacewalker was under construction at Sig when this kit was released. That airplane belongs to Hazel Sig and will be equipped with, you guessed it, six-bay ailerons!

We recommend that you build your model with the six-bay ailerons as shown on the plans, even if you intend to duplicate N107JA or N516MH. Modifying the wing for longer or shorter ailerons should only be attempted by experienced giant-scale modelers. We have flown prototype models with all three types of ailerons and find the six-bay version is the best overall. The only real reason to use the "long" aileron or "short" aileron is perfect accuracy of outline in scale competition. If you do decide to build the eight-bay ailerons, they must be stiffened by adding diagonal ribs between the existing ribs. Also, the ailerons should be covered with a high-strength fabric, such as Sig Koverall, for additional strength and stiffness. Add another hinge to each aileron, move the servo and control horn inboard one rib bay, and make certain that there is no "slop" in the control linkage which could lead to flutter.

Notice that materials for the eight-bay ailerons are not provided in the kit. However, the four-bay ailerons simply require you to cut off the aileron spars and sheeting to the smaller dimension. Leave the servo and control horn in the position shown, and eliminate one hinge.

TAIL ASSEMBLY

Before beginning construction on the tail surfaces, carefully cut out all of the "5", "E", and "R" parts from the 3/8" printed balsa sheet (Sheet #3). A jig saw works best for cutting these out. Cut just outside the lines, leaving all of the lines on the parts. When fitting the parts in the structure, use a sanding block to bring the edges to an exact fit. Pin the plans to the building board and cover them with waxed paper or plastic wrap.

Stabilizer and Elevator

53. Prepare the stabilizer/fin trailing edge by gluing a piece of 1/8"x3/8"x36" spruce to a piece of 3/8"x3/4"x36" balsa. Be sure to keep these parts straight while the glue dries. The spruce laminate increases the strength of the structure and helps to prevent warps from developing. This 36" laminated piece must be used for both the stabilizer trailing edge and the fin trailing edge. There is very little excess, so cut these parts out carefully.
54.
 - a. Pin the laminated elevator trailing edge in place over the plans.
 - b. Cut the stabilizer leading edges from a piece of 3/8"x3/4"x36" balsa. Pin the leading edges in place and glue them together at the center.
 - c. Glue in the 3/8" balsa 5-1, 5-2, and 5-3 center sheeting parts.
 - d. Add the 3/8" sq. balsa ribs and end pieces.
 - e. Glue in the 3/16" x 3/8" balsa diagonal ribs.

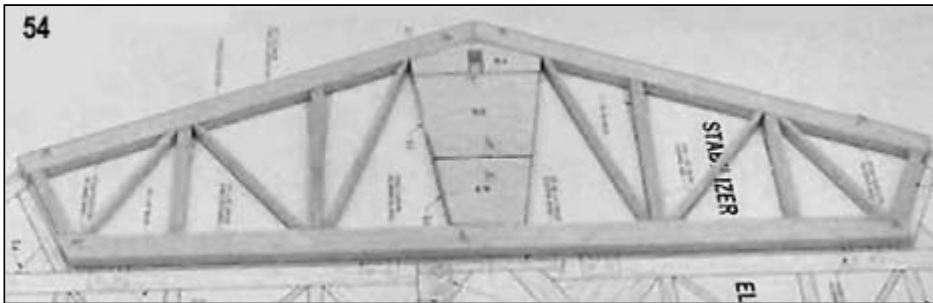

55.
 - a. When dry, remove the stabilizer from the building board and lightly sand the top and bottom to smooth out the glue joints. Use a sanding block to sand all of the edges round. You may find that a line drawn along the center of all the frame pieces can help in getting a consistently rounded edge.
 - b. Trim off the leading edge point as shown on the plans.



56.
 - a. Pin the 3/8" sq. x4" spruce elevator joiner in place on the plans.
 - b. Cut out the elevator leading edges from 3/8"x3/4" balsa, being sure to notch the right-hand one for the elevator joiner. Glue the elevator leading edges to the elevator joiner and pin them in place.
 - c. Add the pre-cut 3/8" basswood control horn mount.
 - d. Cut out the elevator tips and trailing edge pieces from 3/8"x3/4" balsa and pin them in place. These parts will be trimmed to shape later.
 - e. Glue in all of the "E" parts, E-1 through E-6.
 - f. Add the 3/8" sq. balsa ribs and end pieces.
 - g. Add the 3/16"x3/8" balsa diagonal ribs.

HINGING TIPS

When assembling each hinge, leave about a 1/16" gap between the head of the pin and the edge of the hinge when you make the bend. After the bend is made and the pin point is clipped, push the pin head up against the side of the hinge. This will move the bend away from the hinge, preventing it from causing a "bind".

Once you have cut the initial slot in the wood with a knife and widened it slightly with a small saw blade, a thicker saber saw blade can be used to help widen the slot to the proper thickness for the heavy-duty hinges.

Apply a drop of oil or a bit of vaseline to the center "bulge" of the hinges. This will prevent any glue from bonding at the critical hinge joint. Be sure to keep the flat part of the hinges free of oil.

A good way to insure that the hinges are soundly glued to the structure is to apply Sig slow-drying epoxy to each hinge slot using a Sig Mini Glue Gun (SH-627). Smear a layer of epoxy on both sides of the hinges and push them into the slots. Wipe away any excess glue before it dries.

Work with only one control surface at a time. For example, glue the hinges to the stabilizer, allow them to dry, then glue the elevator to the hinges.

NOTE:

Many modelers feel that it is easier to cover the horizontal tail surfaces before they are hinged. If you elect to do this, first test assemble the tail surfaces on their hinges without glue, to insure that a good match between the elevator and stabilizer was obtained during the sanding process. Notice that the tips of the stabilizer leading edge must be trimmed slightly to blend in with the curve of the elevator tips.

57. When dry, remove the elevator from the board and trim it to the correct outline. An easy way to do this is to make a tracing of one elevator half and cut it out. Place the tracing over the elevator, draw around the outline, then sand it down to the line. Repeat for the other half. Lightly sand the top and bottom, and round all the edges as you did with the stabilizer.

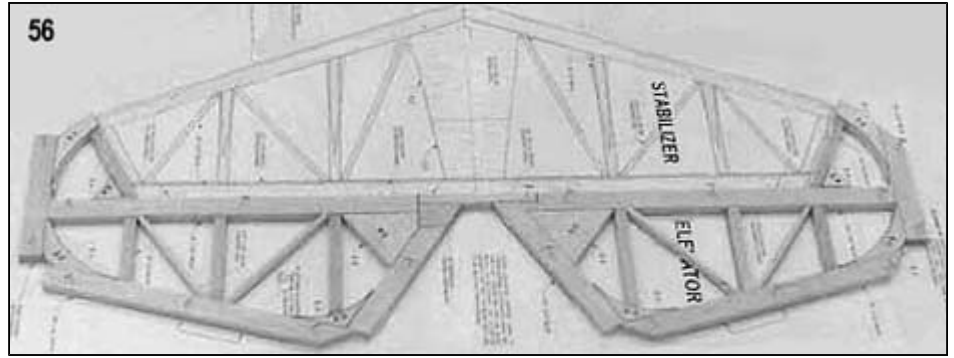

58. Position the heavy-duty elevator control horn on the bottom of the elevator as shown on the plans. Mark the location of the two mounting bolts, then drill the elevator at the marks with a 5/32" drill bit. Countersink the holes slightly on the top of the elevator and install two 4-40 blind nuts. The horn is mounted using two 4-40x3/8" mounting bolts, but not until the elevator has been covered and painted.

59. Install the hinges in the positions shown on the plans. See "Hinge Assembly" (Plate 2) for more detailed instructions.

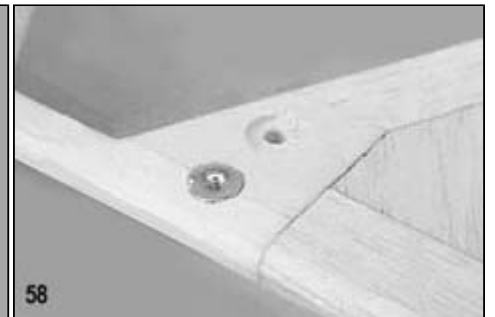

Fin And Rudder

The fin and rudder are assembled over the plan in the same manner as the stab and elevators.

- 60.
- Pin the laminated balsa/spruce fin trailing edge in place. Notice that the trailing edge extends to the bottom of the fuselage.
 - Pin the 3/8"x3/4" balsa fin leading edge in place. Notice that the leading edge extends down below the stabilizer.
 - Glue the four 3/8" sq. balsa ribs in place.
 - Add the 3/16"x3/8" balsa diagonal ribs.
 - When dry, remove the fin from the board and sand the leading edge, top edge, and trailing edge round. Leave the bottom 3/8" sq. balsa rib unsanded so that it can sit against the stabilizer.

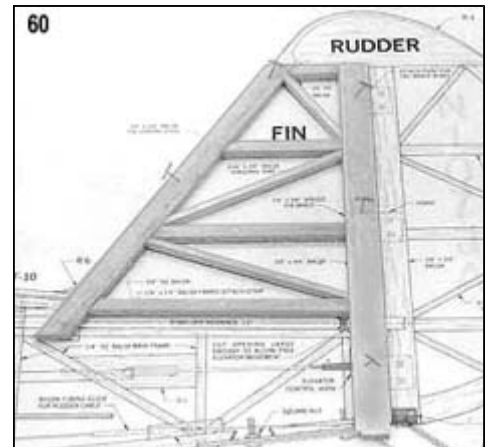

- 61.
- Pin the 3/8"x3/4" balsa rudder leading edge to the plan.
 - Glue R-1 through R-5 in place.
 - Add the 3/8" sq. balsa ribs and 3/16" x 3/8" balsa diagonal ribs.
 - When dry, unpin the rudder and sand all of the edges round.

62. Carefully carve a relief in the bottom of the rudder to accept the rudder horn. Epoxy the horn in place, then drill through the horn and rudder with a 3/32" drill bit. Install a 2-56 x1/2" screw and 2-56 hex nut to anchor the horn to the structure.

63. Install the rudder hinges in the positions shown on the plan.

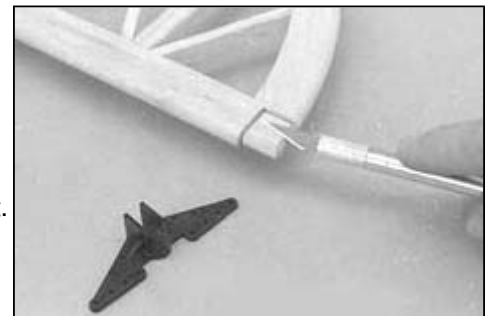

Attaching The Tail Brace Wires

The tail brace wires are a scale feature that will add tremendous strength and rigidity to the entire tail assembly on your model. We recommend that you install all of the wires unless you are specifically building a model of Jesse's prototype. General instructions for installing the wires appear on the plans (Plate 1). The photo shows a typical installation.

Using the plans as a guide, carefully mark the position of each brace wire attach tab on the tail surfaces and fuselage bottom. Drill at the marks with a 3/32" drill bit. Pre-bend the steel tabs to their approximate angle, then fasten them in place using the hardware described on the plans. Apply some Lock-Tite or glue to the nuts to avoid any possibility of them loosening due to engine vibration.



NOTE: The 1/2" long aluminum tubes should be cut in half, making two 1/4" long tubes to clamp the wires. Steel cable is provided in the kit to serve as tail brace wires. Cut each wire about two or three inches longer than necessary so you have some excess to work with, (Remember to save some of this cable for the rudder control system.) Fasten the wires as described on the plans. What you want are eight wires, each with a slight amount of tension. The actual amount of tension is not too important as long as they are all about the same and the tail surfaces aren't twisted or distorted from their normal position.

FUSELAGE CONSTRUCTION

Before beginning work on the fuselage, carefully cut out the WS-1, WS-2, and WS-3 wing saddle pieces from the 1/4" printed balsa sheets (Sheet #2). As with the printed tail parts, cut just outside the lines with a jigsaw or modeling knife. Use a sanding block to fit the parts exactly to the structure.

Before beginning work on the fuselage, you should decide what engine you plan to install. Since there are so many engines available that can be used on the Spacewalker, it was impossible to design the kit with a standard nose section. See "About the Firewall (F-1) Location" on Plate 4 for more information.

If you must build the model before deciding on an engine, it would be better to build the nose too short than too long. That way, a plywood shim or mounting "box" can be added to the front of the firewall if necessary to position the engine correctly. If the nose is too long, it will have to be sawn off and rebuilt.

Prepare the front fuselage main frame drawing (Plate 4) with the correct nose section for the engine that you plan to use. Cover both the front and aft fuselage main frame drawings with waxed paper or plastic wrap.

64.
 - a. Begin construction of the front fuselage main frame by gluing and pinning down the 1/4" sq. spruce pieces along the top, front and bottom.
 - b. Glue in the 1/4" sq. balsa uprights.
 - c. Glue WS-1 in place.
 - d. Fill in the forward two nose sections using a 1/4"x3"x12" balsa sheet. This solidifies the front end which helps to absorb engine vibration.

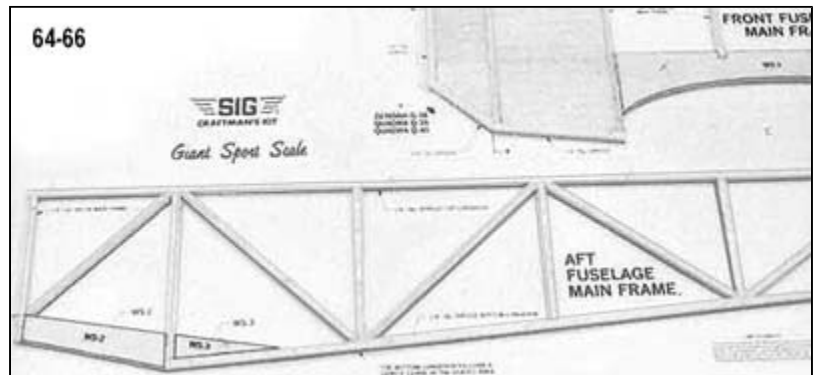

65. Build a second front fuselage main frame exactly as the first. When dry, pin the frames together and lightly even up the edges with a sanding block. Sand both sides of each frame to remove any rough spots or glue "bumps".
66. Repeat the process to construct two aft fuselage main frames.
67.
 - a. Glue the die-cut lite-ply PS-1 pieces to the front fuselage main frames. Be sure to make one right side and one left side! The PS-1 pieces were cut extra long to accommodate any firewall position. Trim and sand the lite-ply even with the main frames.
 - b. Glue the PS-2 pieces to the rear fuselage main frames, again being certain to make a left and a right.

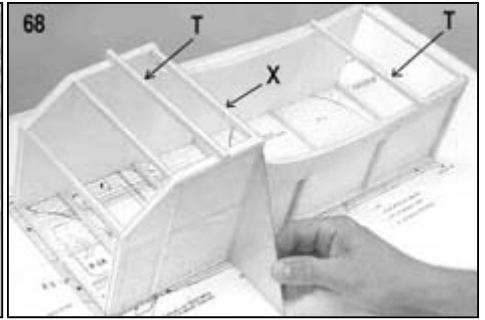
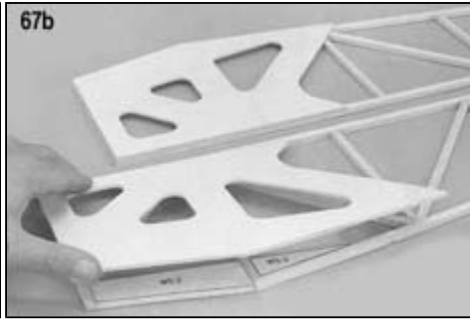
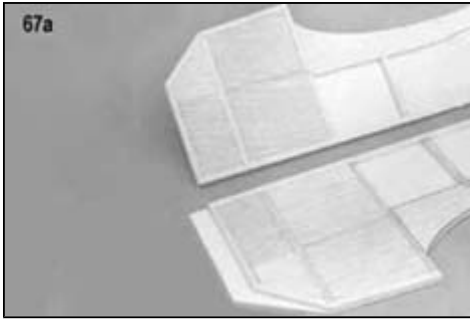

- 68.
- Pin the front fuselage main frames upside-down over the fuselage top view (Plate 1). The plywood side pieces (PS-1) should be facing inward. Make certain the sides are vertical and use temporary braces (marked with a "T" in the photo) to hold them in position.
 - Carefully cut and fit the 1/4" sq. balsa crossbraces and glue them in place. There are six crossbraces on the top of the fuselage (next to the plan) and four on the bottom. Notice that the crossbrace at the front of the wing (marked with an "X" in the photo) should be positioned 1/8" forward of the wing leading edge to make room for the PW plywood pieces to be installed later. Check the squareness of the fuselage several times during this step. When dry, remove the temporary braces.

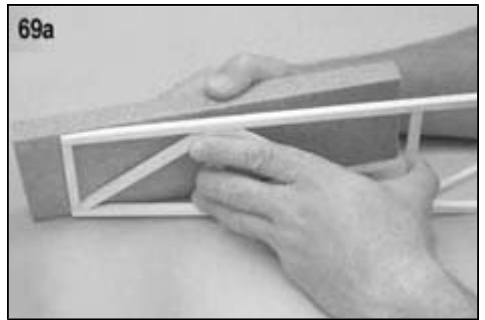

- 69.
- Taper the ends of the aft fuselage main frames where they join at the rear.
 - Pin the aft fuselage main frames upside-down, plywood side pieces facing inwards, on the fuselage top view (Plate 2) and glue them together at the rear. Use a triangle and temporary braces to hold the frames square as you did with the front fuselage main frame.
 - Glue the 1/4" sq. balsa crossbraces between the frames (Seven on top, seven on the bottom).

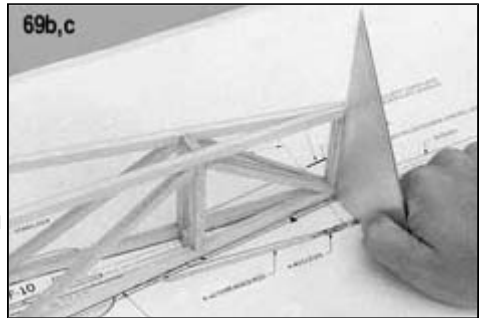

- 70.
- Tape together the two fuselage top views using a long straightedge to make certain the centerline is perfectly straight from the front to the back.
 - Sand the front end of the aft fuselage section with a large sanding block so that it fits flat against the front fuselage section. Check the alignment of the two fuselage sections over the top view drawing. When satisfied with the fit, epoxy the aft section to the front fuselage section and allow to dry.

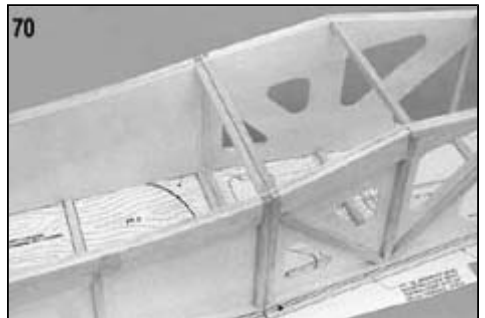

- 71.
- Glue the die-cut lite-ply part PT-2 to the top of the fuselage so that its front edge covers only half of the crossbrace located just aft of F-2.
 - If your engine mount uses bolts that are inserted from the rear of the firewall, you will need to cut an access hole in PT-1 so that you can get to the top two bolts. Glue PT-1 to the fuselage just ahead of PT-2. Trim off any excess.
 - Glue PB-1 to the fuselage bottom with the rear edge even with the front edge of the balsa crossbrace. Trim off the excess at the front so that it is flush with the front face of the fuselage. Sand the rear edge of PB-1 at the same angle as the fuselage bottom.

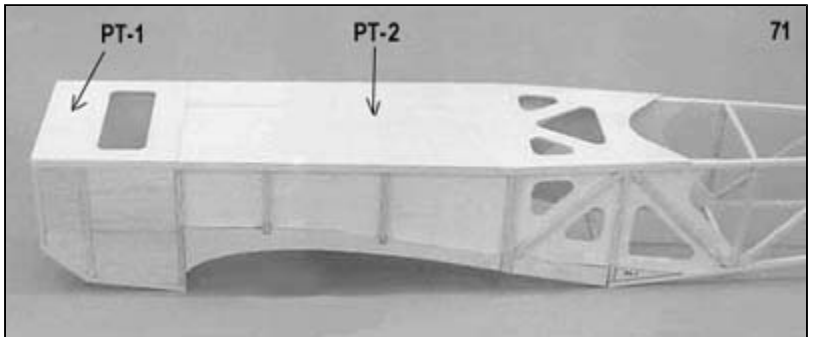

72.
 - a. Construct the firewall by gluing the two 5/32" plywood F-1 formers together with Sig Kwik-Set epoxy. Use a heavy weight to hold the two pieces perfectly flat while drying.
 - b. When dry, use "Cross Section at F-1" drawing (Plate 1) to draw the vertical centerline and thrust line on the firewall.
 - c. Carefully position your engine and engine mount on the firewall and mark the location of the mounting bolts. Drill the firewall at the marks. If you are using blind nuts, they should be installed now and glued firmly in place.

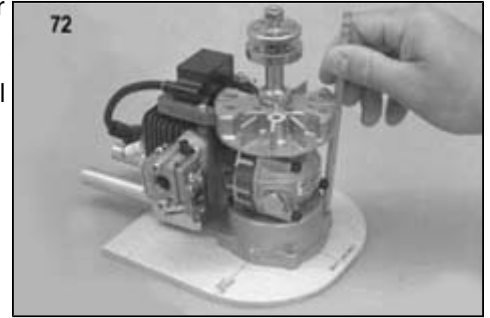

NOTE: The engine shown being fitted to the photo model is a Zenoah G-38 with a B & B Specialties engine mount and muffler. This mount uses four bolts installed from behind the firewall; therefore, blind nuts were not necessary. The two upper bolts are easily accessed through the opening cut into the plywood top, PT-1, in Step 71.

73.
 - a. Epoxy the firewall in place on the fuselage. The thrust line should be level with the top of the spruce longerons and balsa crossbrace, NOT THE TOP OF PT-1!
 - b. Reinforce the firewall/fuselage joint with two lengths of 1" triangle stock, one on each side. (See Photo 88.)
 - c. Carve and sand the bottom edge of the firewall at the same angle as PB-1.

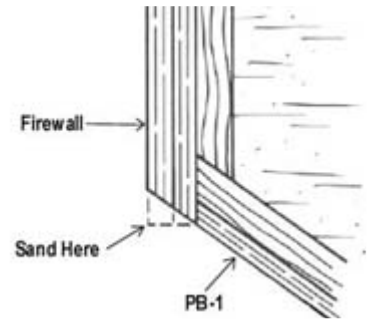

74.
 - a. Glue the lite-ply formers F-4 and F-5 together.
 - b. When dry, glue the F-4/F-5 assembly to PT-2 in the position shown on the plan. Use a triangle to square with PT-2.
 - c. Glue formers F-2 and F-3 to the top of the fuselage in the positions shown on the plans.

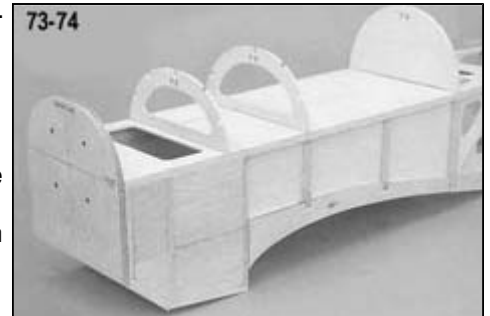

75. The position of F-1A may have to be adjusted vertically on the back of the firewall so that the stringers will be perfectly straight from front to rear. Trial fit several stringers and trim F-1A as necessary to make them straight. When satisfied with the fit, glue F-1A to the back of the firewall.

76. Glue five 1/4" sq. balsa stringers in place between formers F-1A and F-3. Trim the stringers flush with the back edge of F-3.

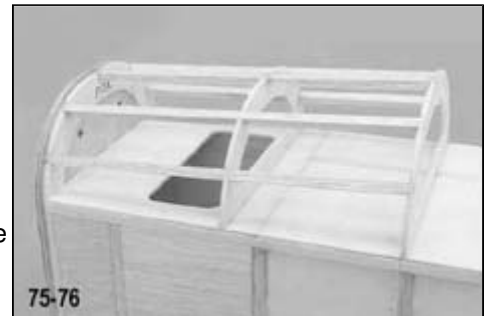

77. Protect the balsa stringers and the edge of F-2 with masking tape, then use a long sanding block to bevel the top edge of the firewall until it is flush with the outer surface of the stringers.

78.
 - a. Three sheets of 1/8"x4"x21" balsa are provided for the front deck sheeting. Start with a full-width sheet in the center. It should just cover about half of the two stringers on either side. The rear edge of the sheeting should just cover F-4, leaving F-5 exposed for the rear stringers and apron pieces to be installed later. It will probably be necessary to soak the outer surface of the balsa with water or alcohol to help it bend around the formers. While wet, gently form the balsa with your fingers to about the right contour, then glue it in place, using tape or pins to hold it until dry.
 - b. Prepare the sheeting for the rest of the front deck by soaking and forming as you did before. When formed to about the correct shape, hold it in place and mark the bottom edge for trimming. It should be trimmed so that it overlaps the edge of PT-1 and PT-2, even with the top edge of the top longeron. Use an easy-to-sand glue, such as Sig Bond, to glue the sheeting in place. Notice that the sheeting tends to bow outwards between formers F-3 and F-4, but most of this is cut out anyway for the cockpit opening.
 - c. When the sheeting has dried, trim off the excess at the front flush with the firewall. Use a long sanding block to sand the sheeting smooth, being careful not to sand away too much material.

79. Use scissors to remove the "Cockpit Cutout Pattern" from the plans (Plate 1). Follow the directions printed on the pattern to cut out the cockpit opening.

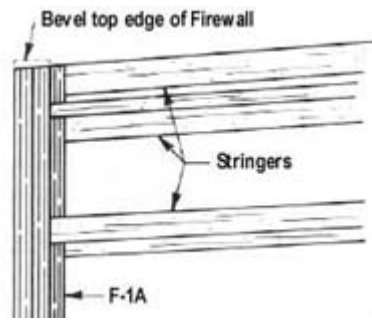

80. Glue the die-cut lite-ply PF pieces to the sides of the fuselage as shown on the plan. Trim off the front edges flush with the firewall and PB-1.

81. a. Position the lite-ply formers F-6 through F-10 over their respective cross-sectional drawings on the plans (Plate 2). Mark the positions of the top stringers on the formers.
 b. Glue formers F-6 through F-10 to the fuselage in their correct positions as shown on the plans. Notice that F-10 is positioned even with the rear edge of the balsa crossbrace. The other formers are centered on their crossbraces. Also be certain that each former is centered left and right on the fuselage.

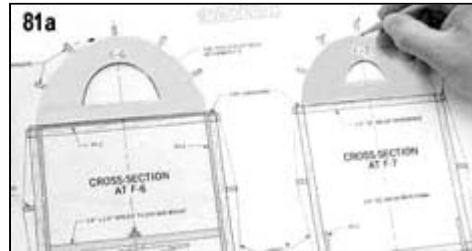

82. Glue the five 1/8"x3/8"x36" balsa top stringers to the former F-5 through F-10. The center stringer should be left extra long at the rear so that it can be trimmed to match the fin later. The two stringers on either side of the center stringer should be rounded at the rear as shown on the plans. The two outboard stringers are cut off flush with F-10. All of the stringers should be perfectly straight from front to rear. Strengthen each stringer-to-former joint with a small fillet of glue.



83. Add the die-cut balsa apron pieces between the stringers. The apron pieces will need to be trimmed on each side for a perfect fit.



84. a. Glue the die-cut lite-ply TM tab mounts to the bottom longerons as shown on the plans.
 b. Add the 1/8"x1/4" balsa fill strips to the bottom of the bottom longerons. Notice that this fill strip ends at the rear-most crossbrace to allow room for the tailwheel mount, TWM.
 c. Glue 1/8"x3/8" balsa fill strips to the sides of the bottom longerons.
 d. Glue 1/8"x1/4" balsa fill strips to the sides of the top longerons on the aft fuselage section.
 e. The 3/16"x1/4" balsa fill strips should now be glued to the side of the top longerons on the front fuselage section.
 f. Add the small 1/8"x1/4" balsa fill strips on the side of the fuselage just forward of the wing leading edge.
 g. Add the 1/8"x1/4" balsa fill strips to the aft fuselage at the wing saddle.
 h. Glue the die-cut balsa FS-1 and FS-2 pieces to the fuselage sides.



Fitting The Wing To The Fuselage

NOTE: The wing center section, completed through Step 38, is needed for the following steps.

85. The wing saddle area must be carved at an angle for the wing to seat properly on the fuselage. Use the plywood side pieces PS-1 and PS-2 to act as guides which should not be altered. Sand the balsa until you reach the edge of the plywood, then stop. Use the Wing Saddle Carving Guide (Plate 2) to check your progress as you work. If you should overcarve, do not fix it by trying to reshape the bottom (which could cause a change in the wing incidence). Instead, fill the gap with model putty. Lay the wing center section in the wing saddle and check the fit.
- 86.
- The remaining two W-1A sub-ribs are positioned in the wing center section so that they line up with the fuselage sides. With the center section positioned accurately on the fuselage, lay a straightedge along the fill strip on the fuselage side so that it extends over the wing. Now mark the bottom leading edge sheeting with a soft lead pencil.
 - Remove the center section from the fuselage and carefully cut away the bottom leading edge sheeting at the line. Don't cut the spar!
 - Trial fit the W-1A sub-ribs and trim as necessary. Glue the subribs into the center section so that they rest against the cut edge of the leading edge sheeting.
87. Two pieces of 5/8"x3-1/4"x1" balsa are provided for landing gear support blocks. These are installed against the back of the leading edge, with the grain running vertically. Notice that the top of the support blocks must be sanded to the contour of the top leading edge sheeting. The bottom of the blocks should be flush with the cutouts on the W-1A sub-ribs. When satisfied with the fit, firmly glue the blocks in place. Look ahead to photo 89-90 to see the blocks glued in place.
- 88.
- Glue the 1/8" plywood PW wing hold-down straps to the inside of the fuselage. The top end of PW butts against the bottom of the 1/4" sq. balsa crossbrace.
 - Brace the back side of PW to PS-1 with 3/4" triangle stock. When dry, carve the triangle stock to match the wing saddle.

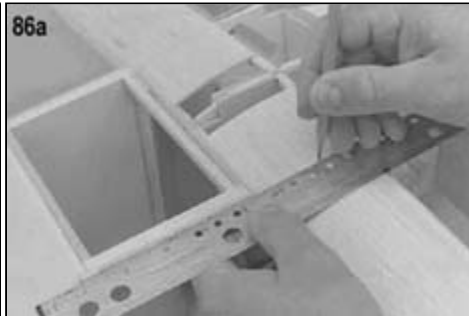

- 89.
- Use the "Cross Section at F-2" (Plate 1) to locate and mark the position of the wing hold-down dowel on PW.
 - Drill PW at the mark with a 1/8" pilot drill, then follow up with a 5/16" drill.
- 90.
- Sharpen one end of the 5/16" dia. x1-1/2" long wing hold-down dowels, being sure to keep the point centered. Push the dowels into the PW pieces from the front so that just the points stick out the backside. (It may seem that the dowels go into the holes awfully hard, but they'll loosen up after they've been pushed in and out a few times.)
 - Carefully slide the wing into position, pushing the sharp dowel points into the wing leading edge.
 - Remove the wing and drill two 5/16" dia. holes through the wing leading edge at the punch marks.
- 91.
- Remove the dowels from the PW wing hold-down straps. Reinsert the dowels from the other side through pieces of wax paper. Only push the dowels in 5/16" - leave most of the dowel length sticking out.
 - Trial fit the wing in position, sliding it onto the dowels. Check to see that the wing still fits the fuselage. If not, slowly enlarge the holes in the wing leading edge until it fits properly. When satisfied with the fit, coat the inside of the holes in the wing with epoxy and slide it back in place on the fuselage. When dry, carefully remove the wing and fill any small gaps around the dowels at the wing leading edge with another application of glue.
- 92.
- The 3/4"x3/4"x3" basswood wing mounting blocks must be beveled on the side so that they fit flat against the fuselage side (PS-2) and the top surface of the wing. Check their fit by installing the wing on the fuselage and holding the block in place. When they fit properly, epoxy the wing mounting blocks in place.
 - Glue lengths of 3/4" triangle stock to the top and front of the wing mounting blocks.

Wing Mount Block (Viewed from end)

This edge against PS-2
This edge against wing



93.
 - a. Tape or pin the wing to the fuselage, making sure that it is in perfect alignment. Carefully and accurately mark the position of the wing hold-down bolts on the bottom surface of the wing. Visually confirm that a hole drilled at the marks will pass through the approximate center of the wing mounting blocks.
 - b. Drill through the wing and the wing mounting blocks at the same time with a #7 (or 13/64") drill bit. Keep the drill perpendicular to the bottom surface of the wing so the heads of the nylon bolts will seat flush against the wing.
 - c. Remove the wing and tap the wing mounting blocks with a 1/4-20 tap. You can apply a few drops of thin C/A to the holes to strengthen the threads.
 - d. Redrill the holes in the wing with a 1/4" drill bit to pass the nylon wing bolts.

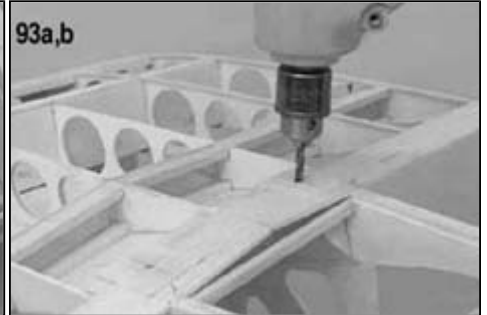

Completing The Fuselage

94.
 - a. With the wing bolted in place, glue F-6A to the fuselage, just behind the trailing edge. You will have to cut away a small portion of the fill strips to make room for F-6A.
 - b. Cut and shape the bottom stringer from a piece of 1/8"x3/8"x36" spruce. Glue the stringer along the center of the fuselage bottom with its front end against the backside of F-6A.
 - c. Trim the die-cut lite-ply PB-2 reinforcements to fit between the bottom stringer and the 1/8"x1/4" balsa fill strips. The outer ends of the reinforcements should rest on the bottom edge of PS-2. Sand the wing trailing edge and fuselage bottom for a good match to each other.
95.
 - a. Mark the positions of the side stringers on the fuselage main frames. Cut and shape the side stringers from 1/8"x3/8"x36" spruce, then glue them in place on the fuselage.
 - b. Use a sanding block with one end covered with heavy paper to sand the fill strips to the shape shown in the fuselage cross sections (Plates 1 and 2). The paper protects the spruce stringers from being taken down while sanding the fill strips. Use the same technique to sand the fill strips on the front fuselage section, including FS-1 and FS-2. Complete the shaping by sanding the corners round on the fuselage bottom.

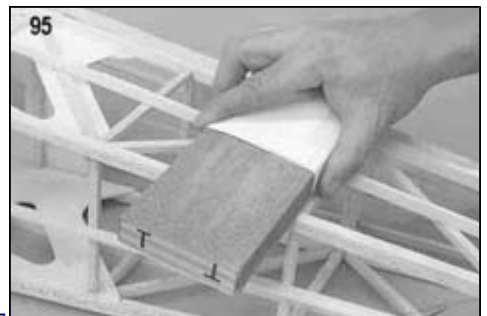
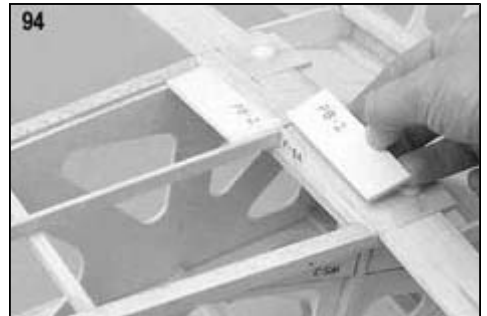

BUILDER'S TIP:

While there is still easy access through the bottom, now is the time to install the fuel tank, throttle pushrod, etc. The fuel tank should be mounted with its' centerline even with or slightly below the centerline of the engine's carburetor. Materials for mounting the tank are not furnished specifically, but there should be plenty of scrap that can be used. The tank supports should hold the tank in its proper position but should also allow it to be pulled out easily if necessary. See "TIPS ON TANKS" , and "THROTTLE HOOKUP".

NOTE: The wing center section, completed through Step 40 is required for the following instruction.



96.
 - a. Glue together the two 3/8"x4"x4-1/2" balsa bottom sheets to form a piece that is 8"x4-1/2".
 - b. With the wing bolted to the fuselage, use a sanding block to bevel the back edge of the bottom sheet so that it sits flush against the landing gear mount in the wing leading edge. When satisfied glue the bottom sheet to the fuselage.
 - c. When dry, sand the bottom sheet to the contours shown in the "Cross Section at F-1" and "Cross Section at F-2" drawings (Plate 1). The bottom sheeting should now blend smoothly into the landing gear mount.

- 97.
- Glue the die-cut lite-ply G-1 pushrod exit guide to the left side of the fuselage as shown on the plan. The outer edge of G-1 should be flush with the outer edge of the fuselage main frame.
 - Glue scrap pieces of 1/8"x3/8"x2" balsa in place on each fuselage side to serve as cable exit guides.
 - When dry, drill the cable exit guides with a 9/64" drill to accept the nylon tubing guides. The holes should be drilled at a shallow angle so that the rudder cables will exit the side of the fuselage in the direction of their attach point on the rudder control horn. Cut two 3" lengths of nylon tubing from the piece provided in the kit and glue them into each of the drill holes. Cut the tubes off flush with the cable exit guides.

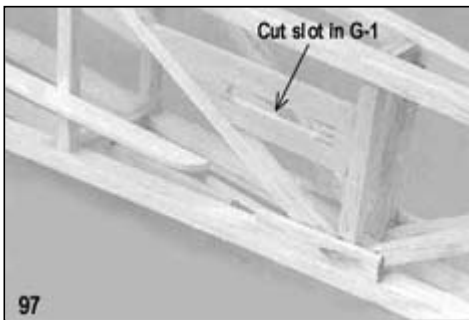

TIPS ON TANKS

The 24 oz. fuel tank shown on the plans will provide sufficient run time for most of the engines that are suitable for the Spacewalker, although there is plenty of room for a larger tank if desired. The plans show a slant type, but other styles may be used as well. The simplest, most trouble-free tank set-up to use in the Spacewalker is normal suction feed with two vents, as shown in the diagram below. Both vent tubes should curve upwards inside the tank. The clunk line on the fuel feed tube must swing freely without hitting the back of the tank. Remember to use a fuel tank stopper and fuel lines that are compatible with the type of fuel to be used.

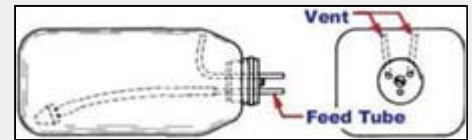

For best results, the fuel tank should be positioned so that its centerline is even with, to 1/4" below, the needle valve on the engine. It can be mounted with scrap balsa supports to hold it in place. Should the need ever arise to remove the tank for servicing, simply break away the balsa supports. You can seal around the hole in the firewall where the fuel lines come through with silicone rubber sealer to prevent exhaust oil from leaking inside the fuselage. Run fuel tubing from the fuel feed line to the carburetor. Two more lengths of tubing run from the vent tubes to the bottom opening in the cowl. To fuel the aircraft, simply pump fuel into either of the vent lines until it runs out the other. Plug one of the vents with a short bolt to keep the fuel from siphoning out. It's not necessary to remove the feed line from the carburetor to refuel. To defuel, turn the fuselage upside-down and pump any remaining fuel out through one of the vent lines. If your engine's muffler is equipped with a pressure tap, you can make use of it to help provide a more reliable fuel feed. To do this, connect one of the vent lines to the pressure tap. The other vent line must still be plugged with a bolt to operate properly. To refuel, remove the vent line from the pressure tap and remove the bolt from the other line, then fill the tank as you normally would.



BUILDER'S TIP:

The task of drilling the holes for the rudder cable guide tubes at the shallow angle can be made easier, as follows. Use a small drill bit (1/16" dia.) or a sharpened piece of music wire to first make a pilot hole. The 9/64" drill bit should then follow the pilot hole with no problem.

Attaching The Tail Surfaces And Tailwheel

NOTE: Many modelers prefer to cover their tail surfaces before attaching them to the fuselage. If you choose to do this, be certain that all the hinge slots are cut and the control surfaces move freely with the hinges temporarily in place.

- 98.
- With the wing bolted in place, position the stabilizer on the fuselage and check its alignment carefully. Be certain it is square with the fuselage by viewing it from the top and rear. When you are satisfied with its position, make small marks on the fuselage and stabilizer so that it can be returned to the same position.
 - If you have already covered the stabilizer, the covering material will have to be cut away (use a sharp razor blade) where the stab rests on the fuselage, so that you will have a strong wood-to-wood glue joint. Epoxy the stabilizer to the fuselage, lining up the marks that you made earlier. Recheck the alignment of the stabilizer as the glue dries, making adjustments as necessary.

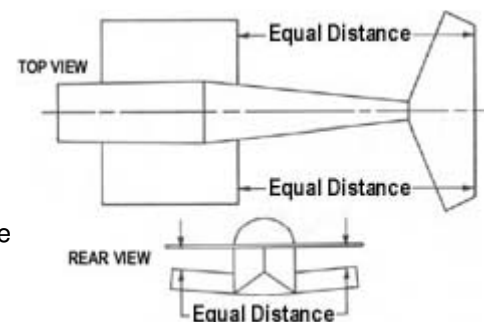

NOTE: The elevator must be permanently hinged to the stabilizer before the fin is attached.

99. a. Trial fit the fin on top of the stab. You will have to trim the center top stringer to fit against the fin leading edge, and the fin trailing edge will need a small cutout to clear the elevator joiner. The extended tail post on the fin should be in good contact with the fuselage end. If the stabilizer has been covered, cut away the covering material where the fin attaches.
 b. Epoxy the fin to the top of the stabilizer and the rear of the fuselage, using a triangle to make certain it is vertical. Also, make sure that the fin is not offset to one side or the other by viewing it from above.
100. a. Brace the bottom of the fin leading edge to the bottom of the stabilizer using small lengths of 3/8" triangle stock. See the "Cross Section at Base of Fin Leading Edge" (Plate 2) for more information.
 b. Install R-6 on the front of the fin. When dry, sand the edge round.
 c. Add the 1/8"x1/4" balsa fabric attach strips to each side of the fin. The bottom edge must be beveled slightly to blend in with the top stringers at the front. The rear edge of the fabric attach strips should blend smoothly into the sides of the fin at the back.
 d. Glue small scraps of 1/8"x3/8" balsa between the outermost top stringers and the balsa fill strips, just forward of the stabilizer leading edge. These scraps provide a place for the covering material to attach in this area.
 e. Blend the fin post into the fuselage sides using scraps of balsa glued to each side of the fin. The balsa scraps should be sanded flush with the fill strips at the front and tapered down to nothing at the back edge of the fin post.
101. a. Position the formed tailwheel leafspring on the die-cut lite-ply TWM tailwheel mount and mark the location of the mounting bolts. Drill TWM at the marks with a 3/16" drill bit. Mount the leafspring using the 10-32 x 3/4" machine screws and the square nuts provided.
 b. Epoxy the nuts firmly in place being careful not to get any glue on the machine screws. When dry, remove the leafspring.
 c. Trim away the balsa fill strips on the bottom longeron in the area where the tailwheel mount fastens to the fuselage. The spruce longerons will have to be relieved slightly to allow room for the square nuts. Drill a relief area into the longerons to clear the rear mounting bolt. TWM should now fit flat against the bottom of the fuselage and fin.
 d. Epoxy TWM in place, being careful not to get any glue in the threads of the square nuts.

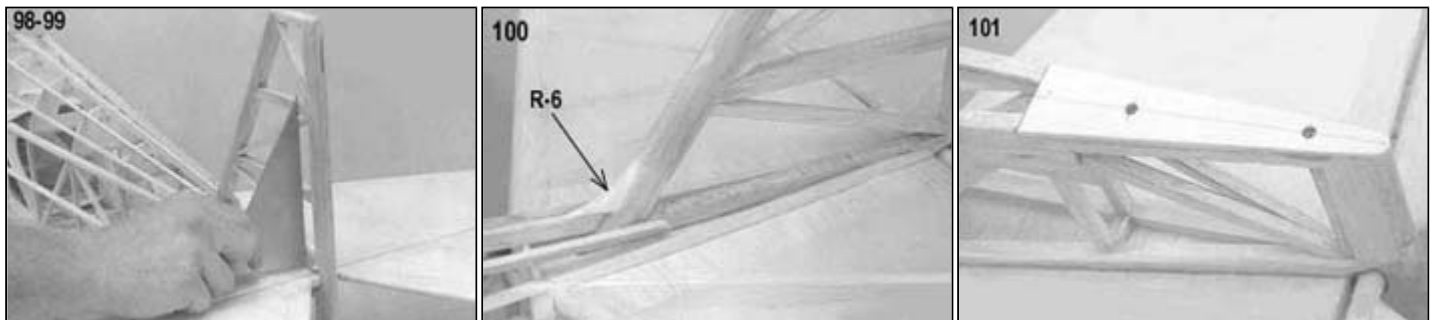

NOTE: The tailwheel steering springs supplied in the kit must be stretched to their proper length before they are installed. Grab each end of a spring with pliers and pull until you feel it "give". Don't overstretch it! It's easier to lengthen it a little more than to shorten it. With no tension on them, the pre-stretched springs should be about two inches long, as shown in the drawing.



LANDING GEAR CONSTRUCTION

NOTE: The completed wing center section is needed before the landing gear can be assembled.

102. Position the 3/16" front main l.g.wire and the 3/16" rear main l.g. wire in the grooved landing gear mounts in the wing center section. The rear landing gear block will have to be notched on both sides to allow the rear wire to swing forward.

HELPFUL HINT:

Under the stress of a painfully hard landing, the 1/8" bottom shock strut wire will want very much to part company with the solder joints that bind it. Now, if those solder joints are flawless, the shock strut wire will surely be held fast. But, since very few of us are flawless, chances are good that our solder joints will be somewhat less than perfect. To help keep the ends of that shock strut wire firmly entrenched between the main l.g. wires, we suggest that you file or grind small notches into the shock strut wire as illustrated here. Now solder will flow into the notches and "lock" the shock strut in place, thus avoiding the unhappy possibility described earlier!

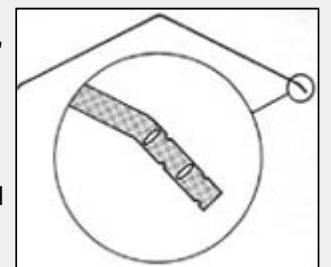

103. Hold the legs of the 3/16" main l.g. wires together and add the 1/8" bottom shock strut wire between them. Rebend the wires slightly, if necessary, to get all of the wires to line up properly. Cyanoacrylate adhesive can be used to hold the wires together temporarily. When you have them aligned, bind them tightly together with copper wire then solder securely. Use plenty of heat and soldering paste so that the solder will flow completely around and through the bindings. Drape a cloth over the center section to protect it from dripping solder or paste.

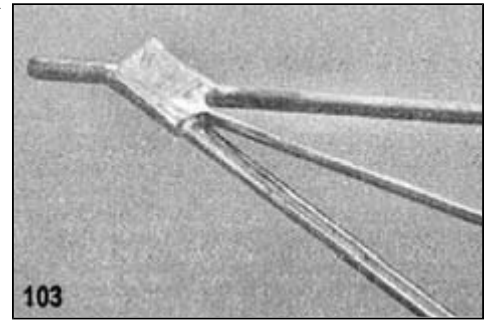

104. Remove the wire gear from the wing, then bind and solder the, 1/8" dia. top shock strut wire in place. After all of the joints are cool, file and sand them to smooth out any prominent bulges in the bindings. Clean all joints with dope thinner or other suitable solvent.

105. Cut a 1" long piece of scrap 1/16" dia. music wire (or similar) from leftover pieces you undoubtedly have in your workshop. Form it into a shallow "V", then bind and solder it to the top shock strut wire. This serves as a hook for wrapping rubber bands around both shock strut wires to act as a shock absorber.

106. Refit the landing gear to the wing. Position the four large nylon landing gear straps over the wires, as far outboard on each side as practical. (Positioning the straps this way will help to prevent the gear from shifting side-to-side during rough landings.) Mark the hole locations for the straps, then pilot drill the landing gear mounts and thread in the screws.

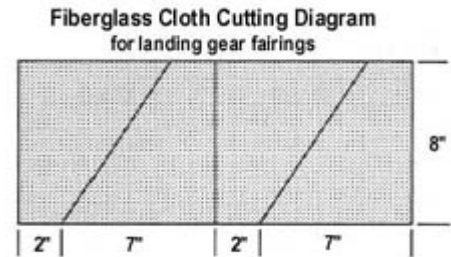

- 107.
- a. A single sheet of 3/16"x4"x12" balsa is provided for fairing in the sides of the landing gear. Cut out pieces to fit between the 3/16" wires, noting the grain direction shown on the plans. Epoxy the fairings in place and allow to dry.
 - b. Heavy-weight fiberglass cloth is provided for reinforcing the landing gear and the fairings. Cover one side at a time using slow-drying epoxy to apply. Lap the cloth past the edges of the wood, completely around the 3/16" wires. When dry, sand smooth.

COMPLETING THE MODEL

Wheel Pants

The directions given below are for a single wheel pant. Of course, you must make two wheel pant assemblies, a left and a right.



- 108.
- a. Clean and sand the inside surface of the pant where the diecut 1/16" plywood mounting plate will attach. Epoxy the plate in place as shown on the plans (Plate 4).
 - b. Carefully locate and mark the position of the axle on the wheel pant using the plans as a guide. Drill through the pant and mounting plate with a 3/16" drill bit.
 - c. Install a 6-32 x 3/8" socket-head set screw into one of the molded nylon wheel pant mounts. Temporarily hold it on the outside of the pant and mark the location of the two outer holes. Drill through the pant at the marks with a 3/32" drill bit. Permanently fasten the wheel pant mount to the inside of the wheel pant with two #4 x 3/8" sheet metal screws.
 - d. You must grind or file a shallow flat spot on the wire landing gear where the wheel pant mount's set screw makes contact. The position of this flat spot will also determine the position of the wheel pant. The flat spot may have to be slightly re-ground several times before the wheel pant assumes the correct angle. The centerline of the pant should generally be parallel with the fuselage top longeron, and both pants should be parallel to each other.

Cowling

- 109.
- The scribe lines molded into the cowling indicate the edges of the air intake openings. Cut out the openings with a sharp knife or a Dremel tool with a drum sander attachment. Bring the cutouts right up to the scribe lines using small sanding tools or a fine-tooth file.
 - Make a cutout in the front of the cowling for the engine's prop shaft. The cutout should leave plenty of clearance for the front end of the engine, but should be smaller than the 3-1/4" spinner dia.
- 110.
- With the engine mounted, tape the cowling into its final position on the fuselage. Check its fit by temporarily placing the 3-1/4" spinner on the prop shaft. When viewed from the side, the spinner should blend perfectly into the top curve of the cowling. Be sure to leave at least 1/16" clearance between the spinner and the cowling. Notice that the back edge of the cowling should be just about even with the back edges of the PF side pieces.
 - Drill mounting holes through the cowling and into the fuselage sides in six places using a 1/16" drill bit. The top two holes on each side should pass directly through the spruce longeron. The bottom hole on each side should also pass through the bottom spruce piece of the fuselage main frame.
 - Thread a #2 x1/2" sheet metal screw into each mounting hole. Remove the spinner, cowling, and engine, then place a drop of thin CIA into each hole to toughen the threads.

111. Trim out the left and right plastic dummy engine cylinders using a -knife or scissors. Use a sanding block to smooth the edges, leaving a 1/16" gluing flange around the cylinders and exhaust pipes. The cylinders can be glued to the cowling before or after painting using thin cyanoacrylate adhesive. Locate the cylinders as shown in the photo.

NOTE: Use the same dimensions shown here for the dummy cylinders on the right side of the cowling. Notice that, when viewed from the top, the right-hand cylinders will be staggered aft of the left-hand cylinders, just as they are on the full-scale Continental engine.

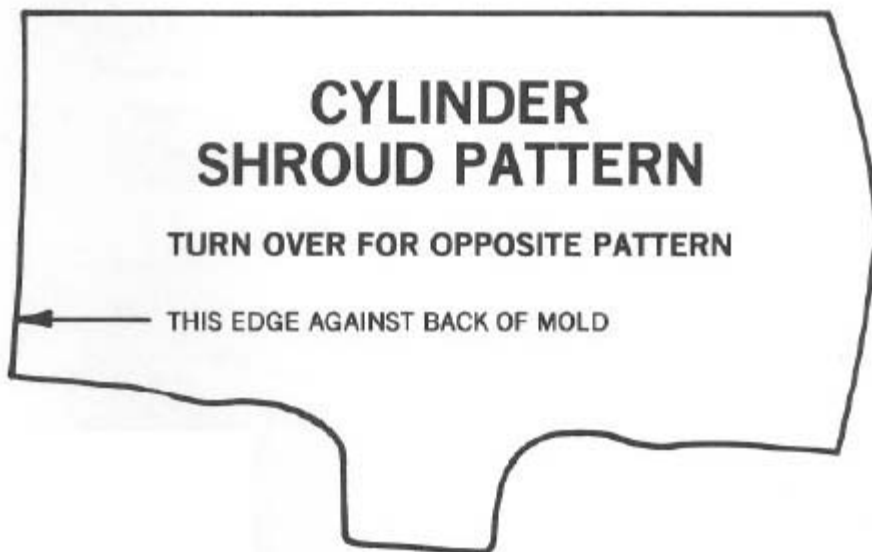

112. Cut out the cylinder shroud pattern and tape it to the plastic molding as shown in the photo. Mark around the pattern and the back of the molding, remove the pattern, and carefully cut out the cylinder shroud. Flip the pattern over and use it to mark the other side of the molding. The shrouds may need a little trimming for a perfect fit on the dummy cylinders. The top edge of the shrouds should be in contact with the cowling, just above the cylinders. The back flange of the shrouds should be pressed up against the back cylinder.

NOTE: The #2 x3/8" screws installed around the valve covers are an optional scale feature and are not included in the kit.



Wing Straps

Two pieces of 1/64"x5/8"x48" plywood are provided for optional wing straps to simulate the aluminum straps used by Maxey Hester on his fullscale Spacewalker. (Jesse Anglin did not install wing straps on the prototype airplane.) The straps may be omitted from the model, but you will probably find that they help cover-up any inaccuracies or gaps at the wing joints. After covering the outer wing panels, the straps may be glued in place so that half of their width is left to overhang past the end ribs. Wrap the strips of plywood completely around the leading edge and cut off any excess at the trailing edge. Make sure that the straps won't interfere with the center section when the outer panels are slid into place.

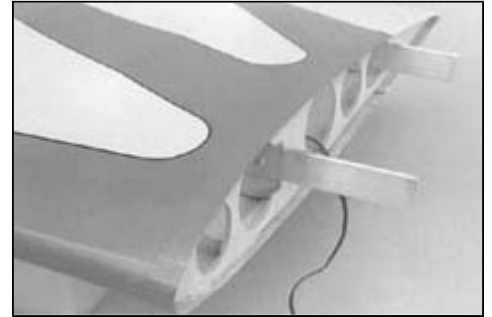

Fuel Cap Cover And Compass Assembly

The teardrop-shaped fuel cap cover should be trimmed from the plastic sheet leaving a 1/16" to 3/32" flange around its perimeter. The flange gives plenty of gluing surface and is scale. For best appearance, paint the cover separately and glue it to the finished fuselage with C/A. The molded plastic compass is assembled in a fashion similar to the plastic shock springs. Cut out the halves as close to the base as possible, then sand each piece until they match and the compass assembly appears round when the halves are held together. Glue the halves together using C/A, dope thinner, or MEK as you did before. The "bulge" at the bottom of the compass was necessary for molding purposes and must be trimmed off after assembly. Paint the compass flat black before gluing it to the painted fuselage.

RADIO INSTALLATION

It is generally easiest to mount all of your radio equipment and pushrods in the model before covering and painting. Once the initial installation has been made and all the bugs worked but, you can remove the radio system and then reinstall it when the airplane is finished.

Mounting Servos in the Fuselage

The fore and aft location of the servos is generally not critical for balancing purposes.

The servos in the photo model were mounted towards the rear of the radio compartment to help keep the pushrod lengths as short as possible. Use wood screws to mount your servos directly to the hardwood servo rails. Cut two servo rails from the 3/8" sq. spruce provided in the kit and epoxy them across the inside of the fuselage with the proper spacing for your servos. Glue scrap pieces of balsa to the fuselage sides around the ends of the servo rails so that they can never come loose in flight.

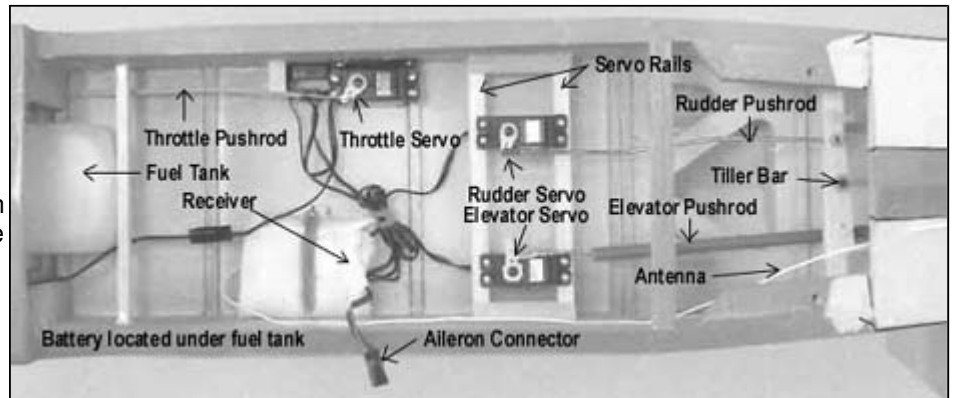

Elevator Hookup

Instructions for assembling the fiberglass elevator pushrod are on the plans (Plate 2). Use 3/32" dia. music wire and a 4-40 solder clevis (supplied in the kit) at the servo end of the pushrod. Notice that after the fuselage is covered, a pushrod exit slot will have to be cut into the fabric. We suggest that you duplicate the full-scale practice of reinforcing around a cutout in the fabric using a thin plastic reinforcement cut from scrap ABS. Use the pattern shown here and apply it to the covering by brushing clear dope on the fabric and pushing the reinforcement onto the wet paint. When dry, the plastic should be firmly bonded and the fabric inside the ring can be cut out with a sharp knife.

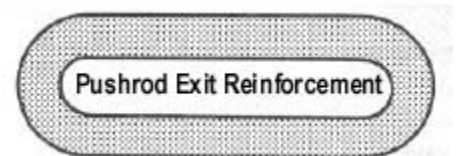

Throttle Hookup

All the materials to assemble a flexible-cable throttle pushrod as shown below are supplied in the kit. It should be supported at the servo end so that it is aimed directly at the output arm on the throttle servo. Cut a support block from scrap balsa and glue it firmly in place against the fuselage side. Epoxy the nylon outer tubing to the support block. Route the cable so that it makes as few curves as possible and provide at least one support between the servo and the firewall to keep it from buckling or flexing under load.

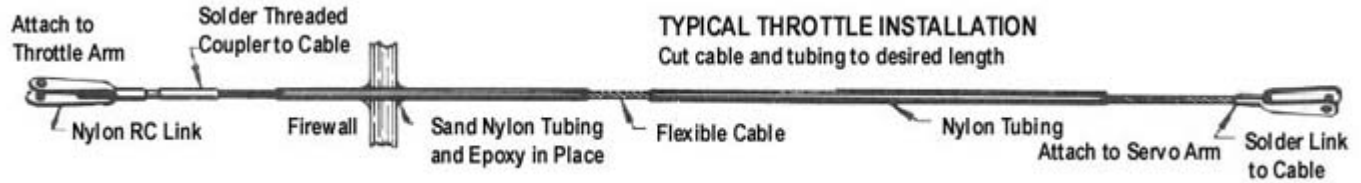

Aileron Hookup

The Spacewalker has been designed to use two aileron servos, one in each outer wing panel. Use servo extension wires with a "Y" harness at the center section to connect the servos to the receiver. Radio manufacturers generally have these items available as stock equipment or will make them on order. It is best to keep the extensions as short as possible since excessively long wires have been known to cause interference under certain conditions.

Installation of the aileron servos and aileron pushrods is clearly shown on the plans (Plates 3 and 4). You will have to cut a clearance notch in the wing's bottom rear spar to make room for the pushrod to travel (hence the reason for the spruce spar doubler at that location). Adjust the 4-40 clevises until both ailerons are lined-up with the rest of the wing. Notice in the photo that a short length of fuel tubing has been forced over the clevis to positively hold the clevis closed. This simple safety feature should be used on all of the clevises used in your model.

Receiver and Battery

Wrap the receiver and battery pack separately in foam rubber (such as SIGRF240), held on with rubber bands or tape, to protect them from engine vibration. The best location in the fuselage for the receiver and battery can't be determined until your model is completely finished. Shifting these components fore or aft can help get the model balanced properly. Be certain that both are secured into position so that they can't shift around in flight.

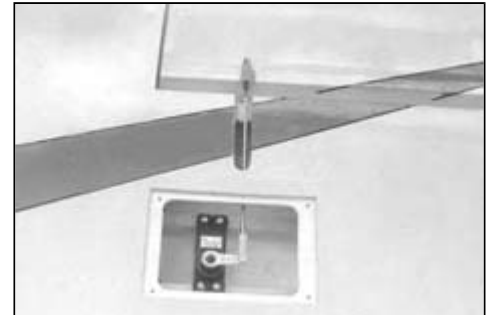

The receiver antenna can be run out of the bottom of the fuselage and taped at the aft end. This will expose the antenna without making it too conspicuous. It may also be mounted inside the fuselage in a long piece of nylon tubing glued into one of the corners. The switch and charging jack can be mounted on PT-2 in the cockpit opening for easy access.

WARNING - DANGER! -Important: Read These Warnings:

- Do Not fly control line or towline models within 300 feet of electric power lines. Instant death from electrocution can result from coming near them. Direct contact is not necessary.
- A model airplane motor gets very hot and can cause serious burns. Do not touch the motor during or after operation.
- Keep clear of the propeller. It can cut off a finger or put out an eye. Make sure the propeller is securely fastened in place and is not cracked.
- Model airplane fuel is flammable and poisonous. Take the same precautions while transporting and using it that you would with a can of gasoline or a bottle of poison.
- Remember that it is possible to lose control of a model airplane. Do not fly in locations where the model may hit people or damage property if loss of control occurs.
- Check your model and equipment regularly to insure it is in safe operating condition.

COVERING AND PAINTING

For the strongest, most durable, and most realistic finish on your framed-up Spacewalker, we recommend that it be covered with some type of fabric, such as Sig Koverall. No matter what you choose for covering material, it will not conceal a rough framework. Be sure all surfaces are sanded smooth before proceeding.

The manufacturer's directions for applying iron-on coverings are packed with the material. Follow these closely, for different types of material have different iron temperatures and techniques of application. The rest of these instructions describe the use of Sig Koverall.



Koverall is a polyester-base, heat-shrinkable, synthetic fabric much like the covering used on full-scale aircraft such as the Spacewalker. Its toughness makes it ideally suited to giant-scale model aircraft - we've used it successfully on all of our Spacewalker prototypes. It is relatively low cost and will add a great deal of strength to the model's framework. One large package of Koverall (KV-003, 48"x5 yd.) is not quite enough to cover this airplane; you will need at least one large and one small (KV-001, 48"x36") package for your Spacewalker. It can be applied to the model using dope or Sig Stix-It, a heat-activated adhesive.

Surface Preparation

Whichever application method is used, you should first brush two coats of clear dope onto the framework wherever the covering material makes contact (even the capstrips on the wing). If you plan to use dope for the entire finish, use Sig Supercoat (butyrate dope) for the first two coats. If you plan to use enamels or epoxy colors, use Sig Nitrate dope. Lightly sand after each coat to remove any raised grain or fuzz.

Applying Koverall With Dope

The bottom of an outer wing panel is a good place to start covering. Cut a piece of material about an inch larger all around the panel, with the grain running spanwise. (The grain of woven materials runs parallel to the finished bias edge.) Lay the Koverall on the wing, pulling out any major wrinkles. Koverall shrinks up considerably under heat - there's no need to worry about such things as packaging fold creases because they will come out easily with the iron. Brush clear dope around all the edges. This will soak through the fabric and adhere it to the dope already dried into the framework. Allow the dope to dry before trimming off the excess material with a sharp razor blade. Check for any rough edges or places that are not stuck down properly and apply more dope, let dry.

Applying Koverall With Stix-It

Directions for applying Koverall with Stix-It are on the can. The basic procedure is to apply Stix-It around the edges of the framework where you want the covering to attach. When dry, the fabric can be ironed-on around the edges where the Stix-It was applied.

Shrinking and Sealing Koverall

After both sides of a surface are covered, shrink the Koverall evenly with an iron or hot-air gun (read the Koverall package instructions). The fabric can now be sealed with three or four coats of clear dope. Thin the dope until it brushes on easily and flows out smooth (about 25% to 30% thinner). The first coat should be applied sparingly to avoid puddles underneath the fabric. The second coat will seal most of the pores of the Koverall and from then on running through will not be a problem. Sand the model VERYLIGHTLY with FINE sandpaper after the second coat is dry. The next two coats will completely seal and begin to fill the weave of the fabric. When dry, sand again. Your Spacewalker is now ready to be finished with its colored paint scheme.

Some Notes on Covering the Spacewalker

The covering on the wing panels can be extended to cover the entire fiberglass wingtip. This will add a little strength to the tip and provides a more consistent surface for the paint.

The fuselage can be covered two different ways. The easiest method is to use four separate pieces of material; one for the bottom, two for the sides, and one for the turtledeck, applied in that order. The turtledeck piece should end about halfway on the small dorsal fin (R-6).

The covering material for the fin is then overlapped 1/4" onto the turtledeck fabric. This does leave a seam, but it can be mostly hidden by applying a few extra coats of dope in this area and sanding lightly. This method was used on the photo model and the seam is hardly noticeable.

A perfectly smooth fin fillet can be achieved by covering the fuselage with three pieces of material; one for the bottom and another two, each covering one fuselage side, half the turtledeck, and one side of the fin. This method is a little trickier, but it does produce fewer seams. Don't shrink the fabric until all of the pieces have been firmly attached to the framework. No matter which way you cover the fuselage, the fabric on the fin should attach to the first 3/8" sq. balsa rib up from the bottom.

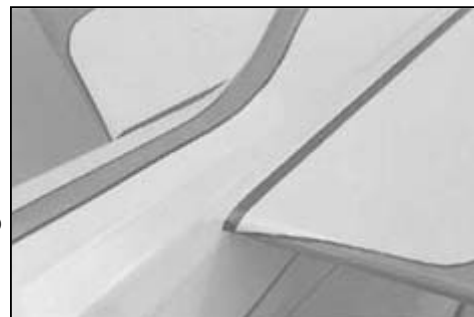

Paint Schemes

The eye-catching "spike" paint scheme used on both Jesse Anglin's red and black prototype and Maxey Hester's yellow and red Spacewalker will take some extra time to duplicate, but is well worth the effort. Both of these full-scale aircraft were painted with Blue River Aircraft Finish.

Paint Formulas to Match N516MH and N516HS

AIR TRACTOR YELLOW

- 2 PARTS SIG LEMON YELLOW
- 1 PART SIG CUB YELLOW
- 1 PART SIG WHITE

COLORADO RED

- 5 PARTS SIG LIGHT RED
- 2 PARTS SIG ORANGE

We found that Sig Light Red and Jet Black are nearly perfect matches for the colors on Jesse's airplane. Maxey's colors can be duplicated using Sig Supercoat Dope in the formulas to the right.

Of course, Sig Cub Yellow and Sig Light Red can be substituted if you aren't interested in a perfect color match. We've found that a light coat or two of Sig White dope provides an even base for the colored dope and actually reduces the total amount of paint necessary. It is generally better to apply light colors first, followed by darker trim colors.

The paint scheme patterns given on the plans can be used for either aircraft. The only difference between the two is the bottom of the wing (see "Fuselage Paint Scheme", Plate 3). The patterns can be cut (or traced) from the plans and positioned directly on the airplane. Draw around the pattern lightly with a soft lead pencil, remove the pattern, and mask off the surface using the lines as your guide. We use "low-tack" drafting tape to mask off paint schemes on our models. Seal the edge of the tape with a coat of clear dope before applying the trim color. If you have used Sig Supercoat Dope throughout, a final coat of clear over the color paint will add a nice gloss to the finish. Do not try to mix different brands of paint. Use Sig products from the start and follow the instructions that come with them carefully for best results.

The pin stripes on both airplanes really help to set off the colors. Jesse used 1/16" wide white tape on his airplane, so finding striping tape for the model in 1/3 scale is impossible. We used 1/16" wide tape on the model and it looked just fine even though it wasn't scale. Maxey Hester solved this problem for the modelers by applying 3/16" wide black tape on his full-scale Spacewalker, so 1/16" tape is perfect for the model.

Other homebuilt Spacewalkers should be appearing shortly all around the country with other paint schemes. If you are not particularly interested in scale competition, you will probably want to come up with your own design. The possibilities are endless!

Painting the Fiberglass Parts

To fill any cracks, small voids, or seams, use a fiberglass filler compound or make a putty by mixing talcum powder with fiberglass resin. The mixture should be about the consistency of soft margarine. Add hardener based on the original amount of resin used. Smooth into the imperfection and allow it to set up. When partially hardened, it can be easily trimmed with a knife. When completely set up, sand smooth. Sand all of the fiberglass parts enough to remove the glossy outer finish.

Dope will not stick to unprimed fiberglass. We recommend using a filler coat of K&B Epoxy Primer or Hobby Poxy Fast Fill. Dope will adhere to this fairly well, but take some care when applying and removing masking tape. Of course, enamels and epoxy paints may also be used over the primed surfaces.

Painting the ABS Plastic Parts

The plastic parts should be sanded to remove the gloss before they are painted. Use only 220-grit or finer sandpaper. We recommend that the plastic parts be painted with Sig Supercoat Dope or Sig Skybrite paint for best results. Sig Plastinamel, Hobby epoxy, K&B Super epoxy, and Dulux (automotive) enamel have also been proven compatible with ABS plastic and can be used if desired. Skybrite primer or K&B primer may also be used for a smooth undercoat. Do not use other paints, dopes, or finishes without first testing to make certain it is compatible with the plastic. CAUTION: Do not try to cover the ABS plastic parts with Monokote or other iron-on types of covering material. The heat may melt and distort the plastic.

Decal Application

All the decals necessary to duplicate N107JA, N516MH, and N516HS are supplied in the kit. Notice that the curved Spacewalker logos have been pre-aligned with the little spacemen so that they can be applied in one piece. Study the plans and the pictures in this book for proper placement.

Model fuels are hard on decals. Even if you are using no nitromethane in your fuel, the oil can still get under the decals and loosen them. Try to direct your exhaust out to an area without decals. Coating the decals with auto paste wax will help protect them, but the wax must be replaced at regular intervals. If needed, replacement decals are available from Sig (order SIGDKM261).

- Cut out the decals with a pair of sharp scissors. Leave about 1/32" to 1/16" of clear edge around the decal. Round the corners as you are cutting.
- Wet the surface on which the decal will be placed with soapy water (use dishwashing detergent).
- Place the decal on the model and squeegee the water from underneath with a balsa paddle and allow to dry.

This procedure will prevent air from being trapped underneath as is possible when the decals are applied dry.

Interior Detailing

Some modelers enjoy spending many hours providing their models with intricate detailing, while others spend no time at all. The cockpit area of your Spacewalker can be given as much scale detailing as you wish, however no materials (except for the plywood instrument panel) are provided in the kit. The following recommendations will add immensely to the overall impact and realism of the model without taking too much time.

Paint the Interior

The wood inside the cockpit must be protected with several coats of clear dope. Once it is sealed, some flat black or gray painted on the exposed areas will help give a less obtrusive appearance.

Instrument Panel

Both Jesse Anglin and Maxey Hester used a plywood panel in their airplanes, so the die-cut 1/16" plywood instrument panel provided in the kit will appear very realistic when finished with several clear coats of dope or varnish. Several manufacturer's make 1/3-scale aircraft instruments that can be fitted to the panel to give your model an added touch of realism. After painting and adding details to the panel, it can be glued permanently in place against former F-3.

Pilot

A few manufacturer's also produce 1/3-scale pilots that are easily painted and mounted to the plywood top. Notice that the pilot should be placed well towards the back of the cockpit opening.

Pre-Flight Checkout

Be certain to range check your radio equipment according to the manufacturer's instructions before attempting test flights. A lot of problems can also be avoided if your engine has been well broken-in and the idle adjustment perfected on a test stand or in another airplane before installation in the new model.

Adjust your pushrod linkages to produce the amounts of movement listed below. Measurements are to be made at the trailing edge of the control surface.

RECOMMENDED CONTROL SURFACE MOVEMENTS	ELEVATOR	1-1/8" UP and 1-1/8" DOWN
For test flights, the following are suggested:	RUDDER	2" LEFT and 2" RIGHT
	AILERON	1-1/16" UP and 15/16" DOWN

The control measurements listed above should give full aerobatic capability if your Spacewalker is properly balanced. Test flights may indicate a need for more or less movement, depending on individual model performance and personal preference.

NOTE: If you have built your Spacewalker with the short (4-bay) ailerons, increase the throws given above by another 3/8" in both directions.

Balance your model somewhere in the C.G. (Center of Gravity) Range shown on the plans. For test flights it is better to balance in the forward portion of the range than in the rearward portion. Add weight to the nose if necessary - trying to fly with the C.G. too far back is much more dangerous than the slight increase in wing loading caused by adding lead to the nose!

FLYING



The Spacewalker has proven to be one of the most exciting models that we've ever flown. Although it will perform the full range of aerobatic maneuvers, it will settle down for slow, stable landing approaches and touchdowns. It's a fun and easy aircraft to fly, but it is not a basic trainer. Do not attempt to fly your Spacewalker unless you've logged some flight time on other low-wing aircraft. Have an experienced pilot assist you, particularly on test flights.



In the air, you will find the Spacewalker to be very smooth and stable. It's aerobatic capabilities will definitely please any sport pilot. After the model has been trimmed and you are more familiar with its flying qualities, you may want to experiment with slight changes in control surface travel and balance point until the model flies and reacts just the way you like it. Advanced pilots who are striving for maximum realism and smoothness should "coordinate" their turns by adding a small amount of rudder at the same time, and in the same direction, as the aileron. Many of the newer radio systems offer a "coupling" feature which will automatically deflect the rudder slightly when you use the aileron stick. We have used this feature successfully on our Spacewalkers. The proper amount of rudder movement is about 3/4" each direction with full deflection of the ailerons.

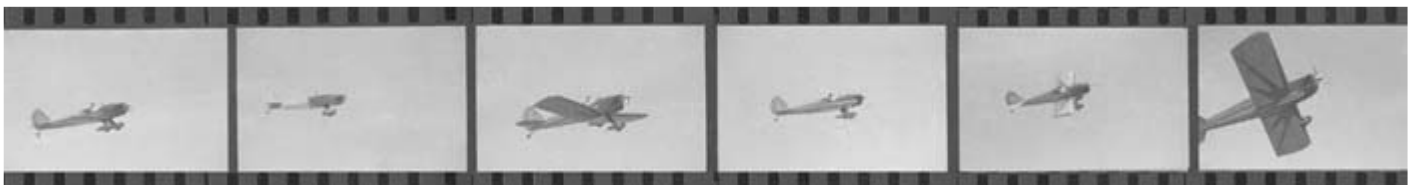

When the time comes to land your Spacewalker, remember to keep your control inputs smooth and gentle to avoid overcontrolling. When you are certain that the model will make it to the runway (even if the engine quits), bring the throttle to full low and concentrate on keeping the wings level during final approach. Slow the model down during the entire approach by slowly feeding in up elevator. Just before the model touches, flare the landing by carefully feeding in more up elevator. Hold the model just inches off the ground until your elevator stick is pulled all the way back. The Spacewalker should settle down to a perfect "threepoint" landing with a short rollout. Taxi back slowly and graciously accept all the praise offered by onlookers. Your Spacewalker will surely be the hit of the flight line!



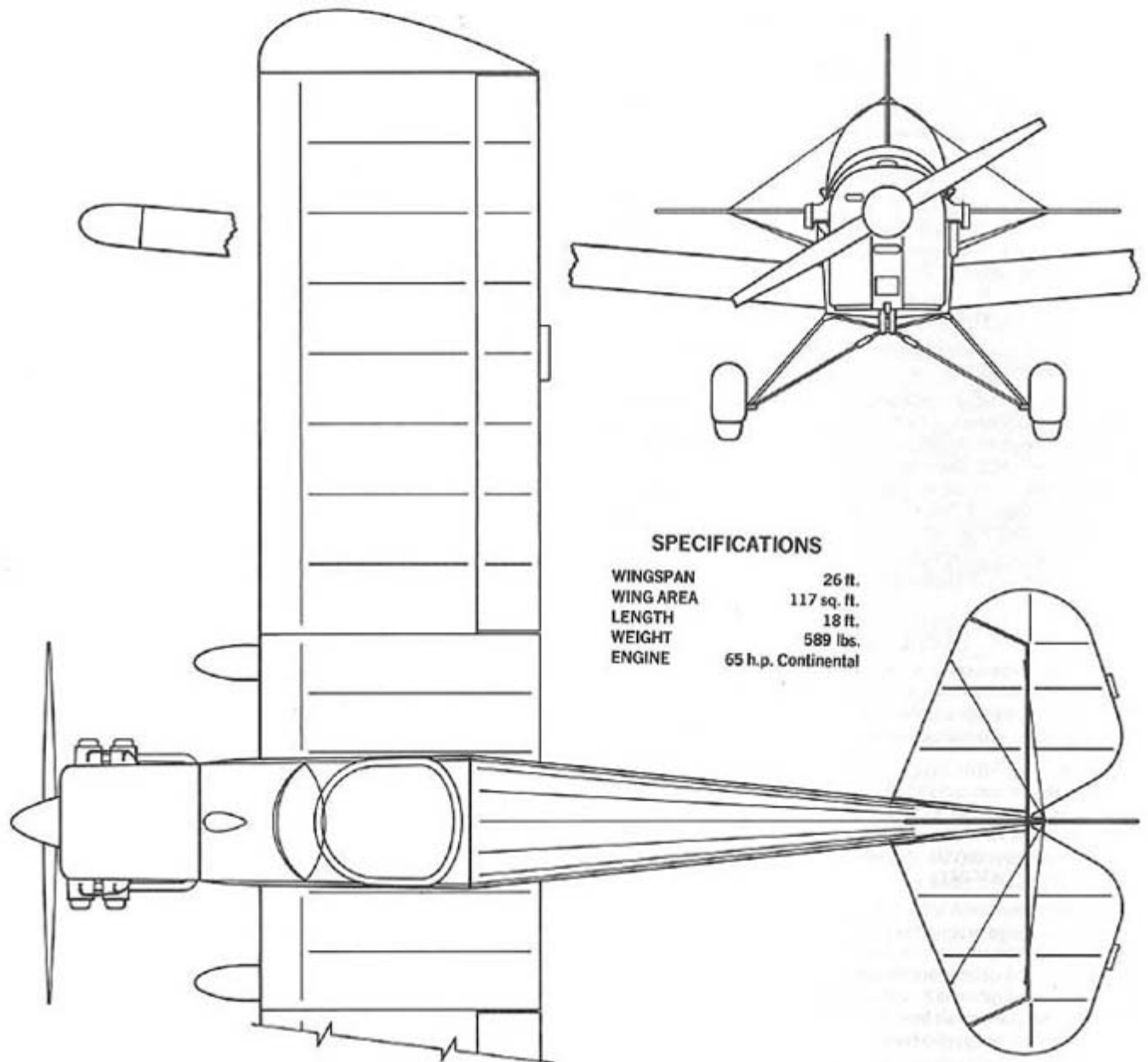

SPECIFICATIONS

WINGSPAN	26 ft.
WING AREA	117 sq. ft.
LENGTH	18 ft.
WEIGHT	589 lbs.
ENGINE	65 h.p. Continental

SCALE: 1/30

PERFORMANCE

TOP SPEED	125 m.p.h.
CRUISE SPEED	110 - 115 m.p.h.
STALL (POWER OFF)	42 m.p.h.

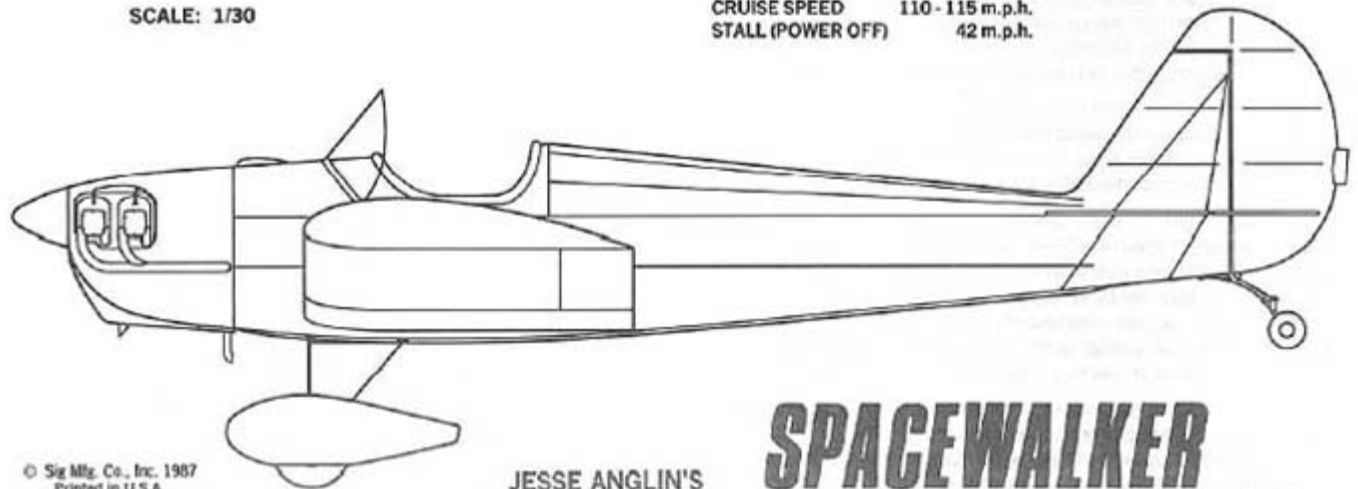

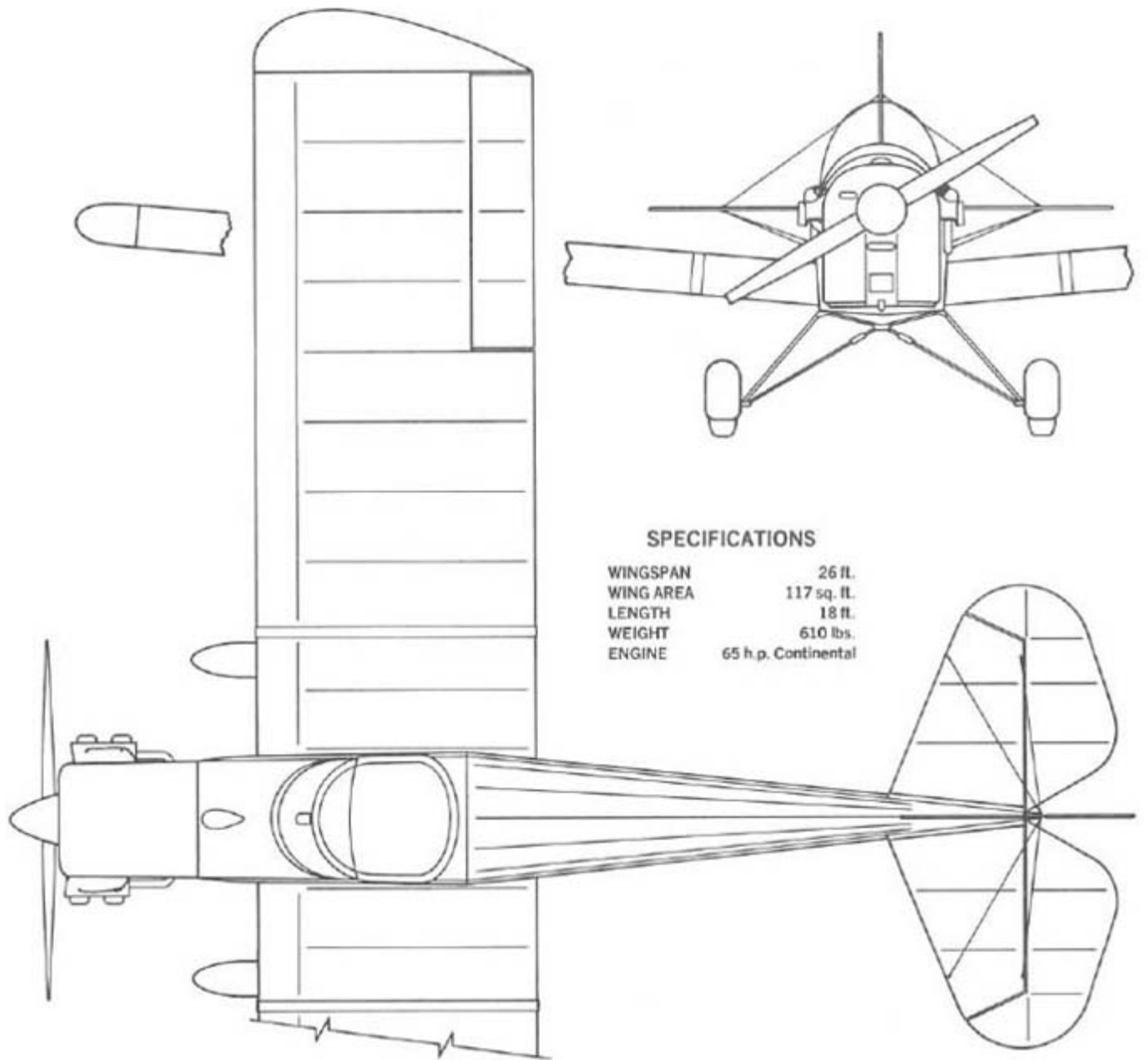

SPECIFICATIONS

WINGSPAN	26 ft.
WING AREA	117 sq. ft.
LENGTH	18 ft.
WEIGHT	610 lbs.
ENGINE	65 h.p. Continental

SCALE: 1/30

PERFORMANCE

TOP SPEED	125 m.p.h.
CRUISE SPEED	110 - 115 m.p.h.
STALL (POWER OFF)	42 m.p.h.

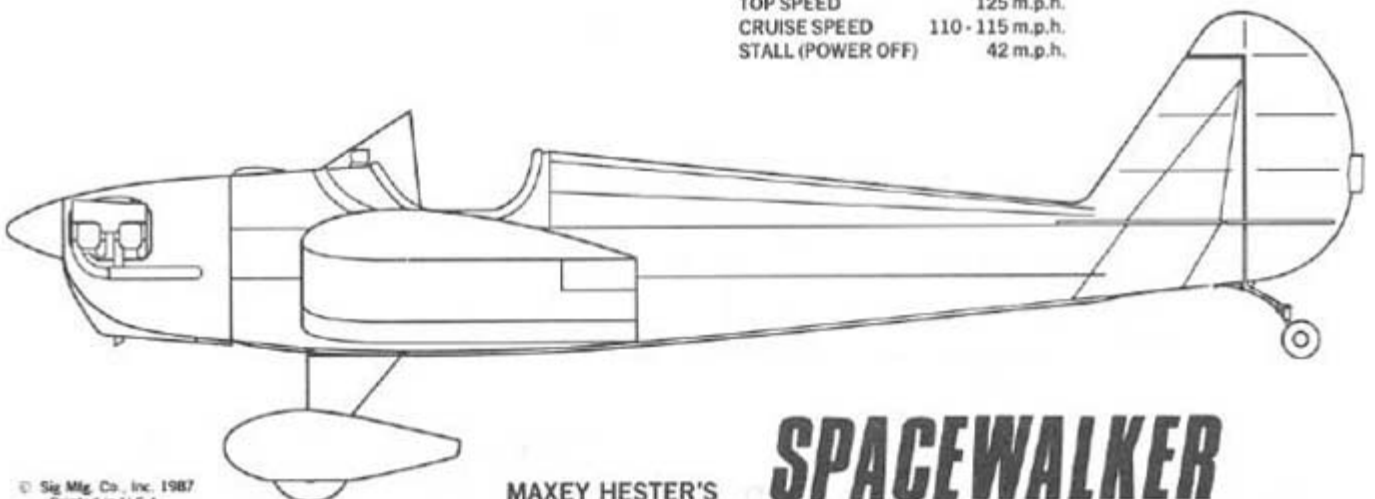

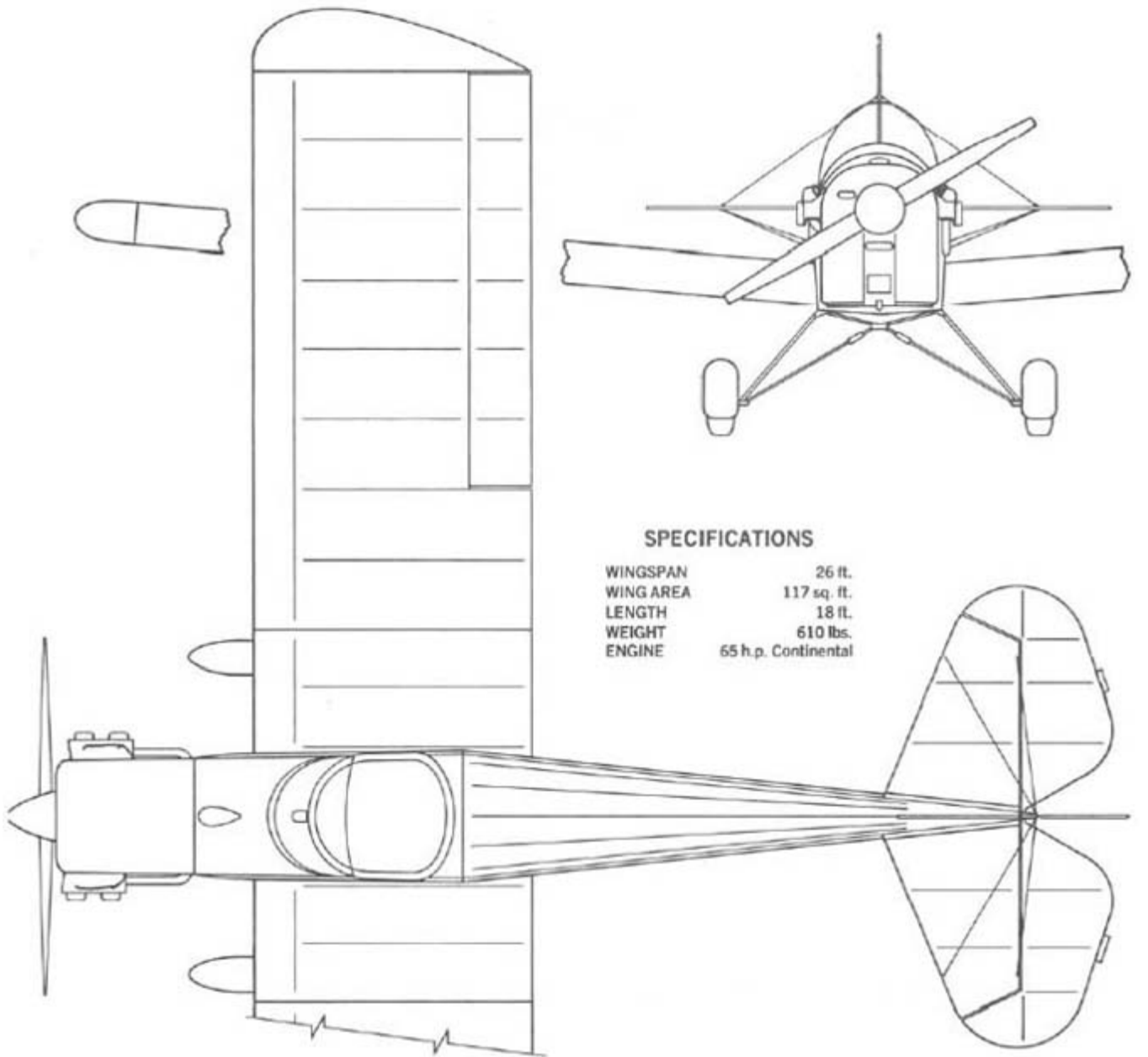

SPECIFICATIONS

WINGSPAN	26 ft.
WING AREA	117 sq. ft.
LENGTH	18 ft.
WEIGHT	610 lbs.
ENGINE	65 h.p. Continental

SCALE: 1/30

PERFORMANCE

TOP SPEED	125 m.p.h.
CRUISE SPEED	110 - 115 m.p.h.
STALL (POWER OFF)	42 m.p.h.

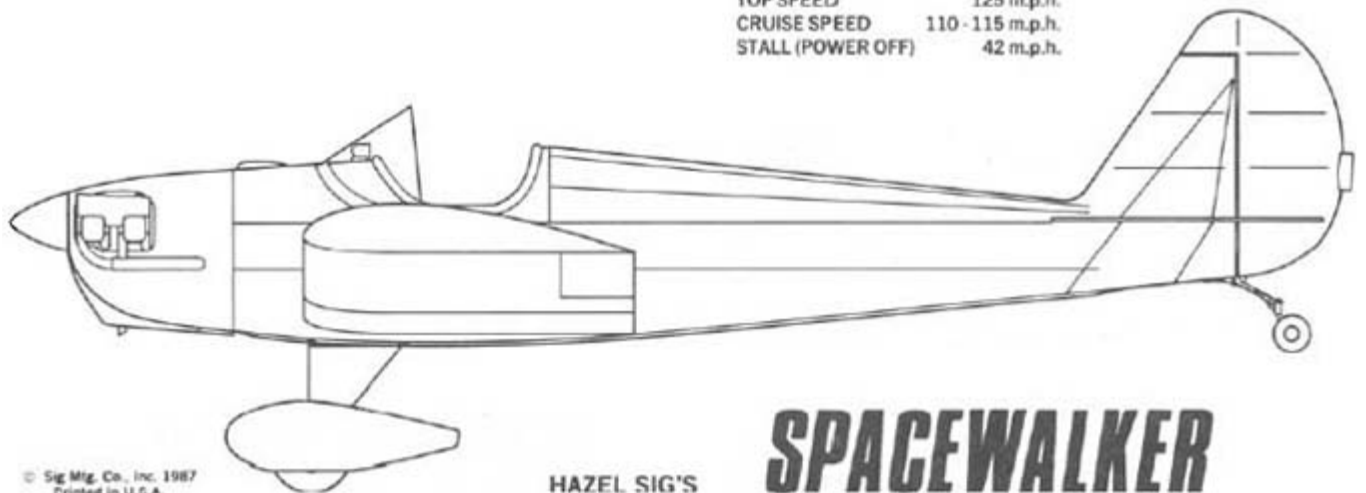

Join Revised Windshield

WINDSHIELD PATTERN

**JESSE ANGLIN'S REVISED WINDSHIELD,
ALSO USED BY MAXEY HESTER
AND HAZEL SIG**

Unhappy with the looks and the poor wind protection of the original windshield, Jesse decided to go with an enlarged version with more slope. This not only improved the looks of the aircraft, it added a few m.p.h. to its top speed as well! This same windshield pattern was also used by Maxey Hester on N516MH and Hazel Sig on N516HS.

INSTALLING THE WINDSHIELD

Cut out the windshield pattern of your choice and place it on the 8-1/2" x 17" clear plastic material provided in the kit. Trace around the pattern (a ball point or permanent-ink felt pen work well for this), then cut it out using a knife or scissors. The edges of the plastic may be sanded smooth, but be careful not to scratch the flat surfaces.

Cyanoacrylate adhesive works best for gluing the windshield to the painted fuselage. (Don't use C/A "accelerator" or "kicker" which could permanently fog your plastic windshield.) A little patience during this step will usually be rewarded with a neat-looking installation.

With the windshield taped down in its final position, tack glue it in several places along its edges. Then go back and glue the edge permanently, removing the tape as you go.

© Sig Mfg. Co., Inc. 1987
Printed in U.S.A.

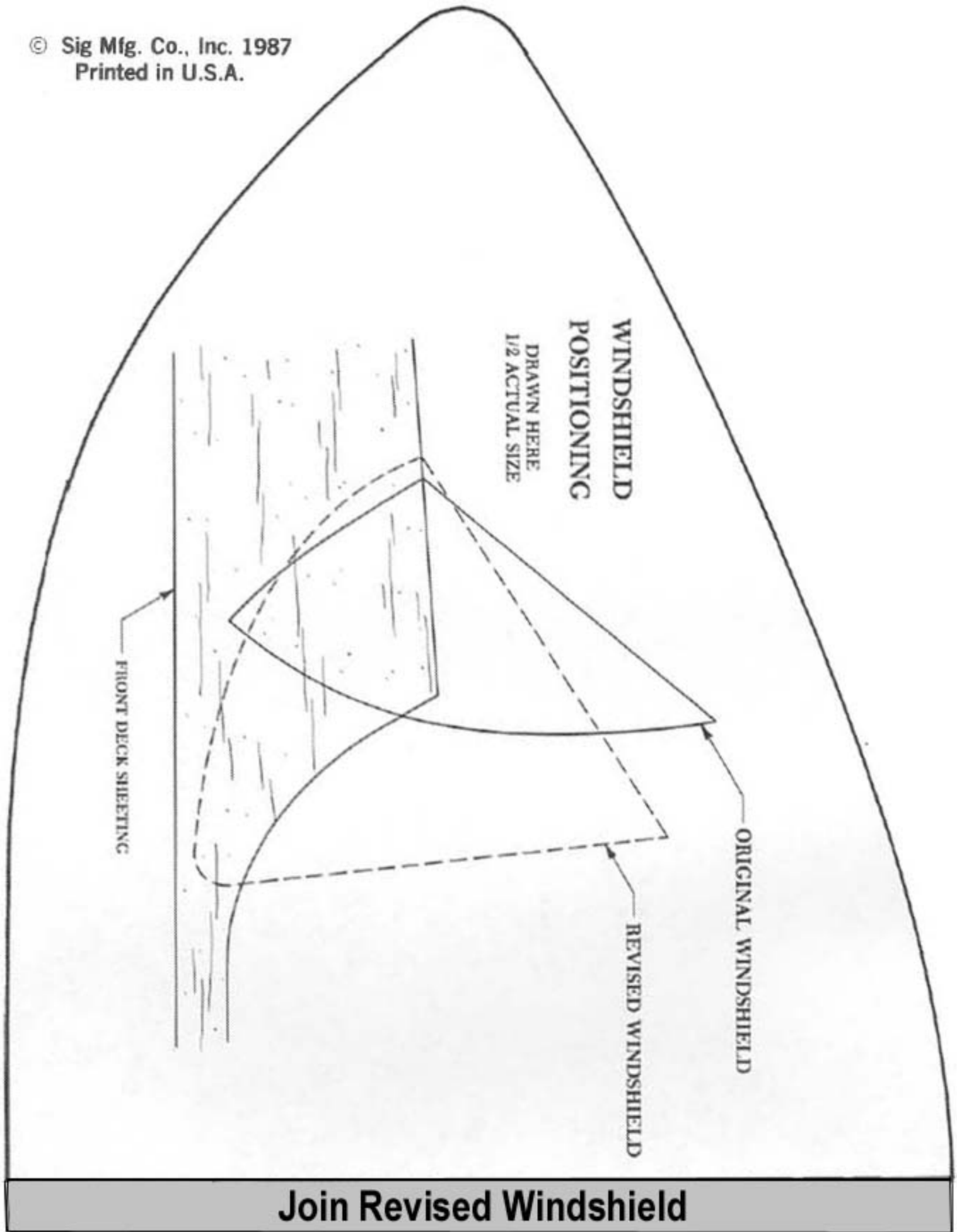

LIMIT OF LIABILITY:

In use of our products, Sig Mfg. Co.'s only obligation shall be to replace such quantity of the product proven to be defective. User shall determine the suitability of the product for his or her intended use and shall assume all risk and liability in connection therewith.



WINDSHIELD PATTERN

JESSE ANGLIN'S ORIGINAL WINDSHIELD

This is the windshield originally used by Jesse Anglin on the prototype full-scale Spacewalker. Position it on the fuselage as shown in the diagram.

Join Windshield



Join Windshield